

Disney Parks Blog

presents:

# Disney Paper Parks



"It's a Paper Holiday!"

designed by  
Stephanie Jazmines,  
Amy Young,

Claire Weiss, Bryce Schulte,  
Greg Ashton and Ron Lee.

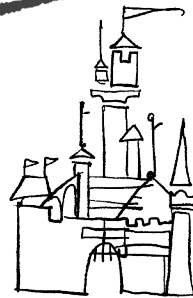

Walt Disney IMAGINEERING  
© Disney



# Disney Paper Parks

#DisneyMagicMoments | #DisneyPaperParks

## 12 DAYS OF DISNEY PAPER PARKS

Ornament List

### HISTORY

The holiday season is well underway in Disney Parks and Resorts around the world. We invite you to bring the Disney holiday spirit into your home with the next edition of Disney Paper Parks!

Each day, you can build your own paper ornaments. There is one from each of our 12 parks around the world! From the original Disneyland, opened in 1955, to the most recent Shanghai Disneyland, opened in 2016, Disney Parks have captured the imagination of generations of people all over the world.

### CELEBRATE DISNEY PARKS AROUND THE WORLD!

Day 1: *DISNEYLAND® PARK, 1955*

Day 2: *DISNEY CALIFORNIA ADVENTURE® PARK, 2001*

Day 3: *MAGIC KINGDOM® PARK, 1971*

Day 4: *EPCOT®, 1982*

Day 5: *DISNEY'S HOLLYWOOD STUDIOS®, 1989*

Day 6: *DISNEY'S ANIMAL KINGDOM® THEME PARK, 1998*

Day 7: *DISNEYLAND PARIS, 1992*

Day 8: *WALT DISNEY STUDIOS PARK, 2002*

Day 9: *HONG KONG DISNEYLAND PARK, 2005*

Day 10: *SHANGHAI DISNEYLAND PARK, 2016*

Day 11: *TOKYO DISNEYLAND PARK, 1983*

Day 12: *TOKYO DISNEYSEA PARK, 2001*

### MATERIALS



Glue



Scissors







Crayons

### GUIDE

#### Lines

- Valley fold, fold in front
- ..... Mountain fold, fold behind
- Cut
- ..... X-ray or guide line.

#### Arrows

-  Fold in this direction.
-  Fold behind.
-  Unfold.
-  Fold and unfold.
-  Turn over.

Please Note: When cutting with scissors and working with any of the materials listed above, adult participation and supervision is recommended.



# Disney Paper Parks

#DisneyMagicMoments | #DisneyPaperParks

## 12 DAYS OF DISNEY PAPER PARKS

Finished Ornament Reference Sheet



Day 1:  
Disneyland



Day 2:  
Disney California Adventure



Day 3:  
Magic Kingdom



Day 4:  
EPCOT



Day 5:  
Disney's Hollywood Studios



Day 6:  
Disney's Animal Kingdom



Day 7:  
Disneyland Paris



Day 8:  
Walt Disney Studios Park



Day 9:  
Hong Kong Disneyland



Day 10:  
Tokyo Disneyland

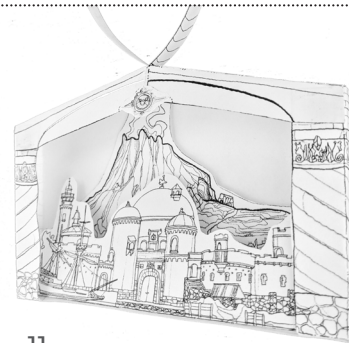

Day 11:  
Tokyo DisneySea



Day 12:  
Shanghai Disneyland





# Disney Paper Parks

#DisneyMagicMoments | #DisneyPaperParks

## DAY 1: DISNEYLAND

Main Entrance View

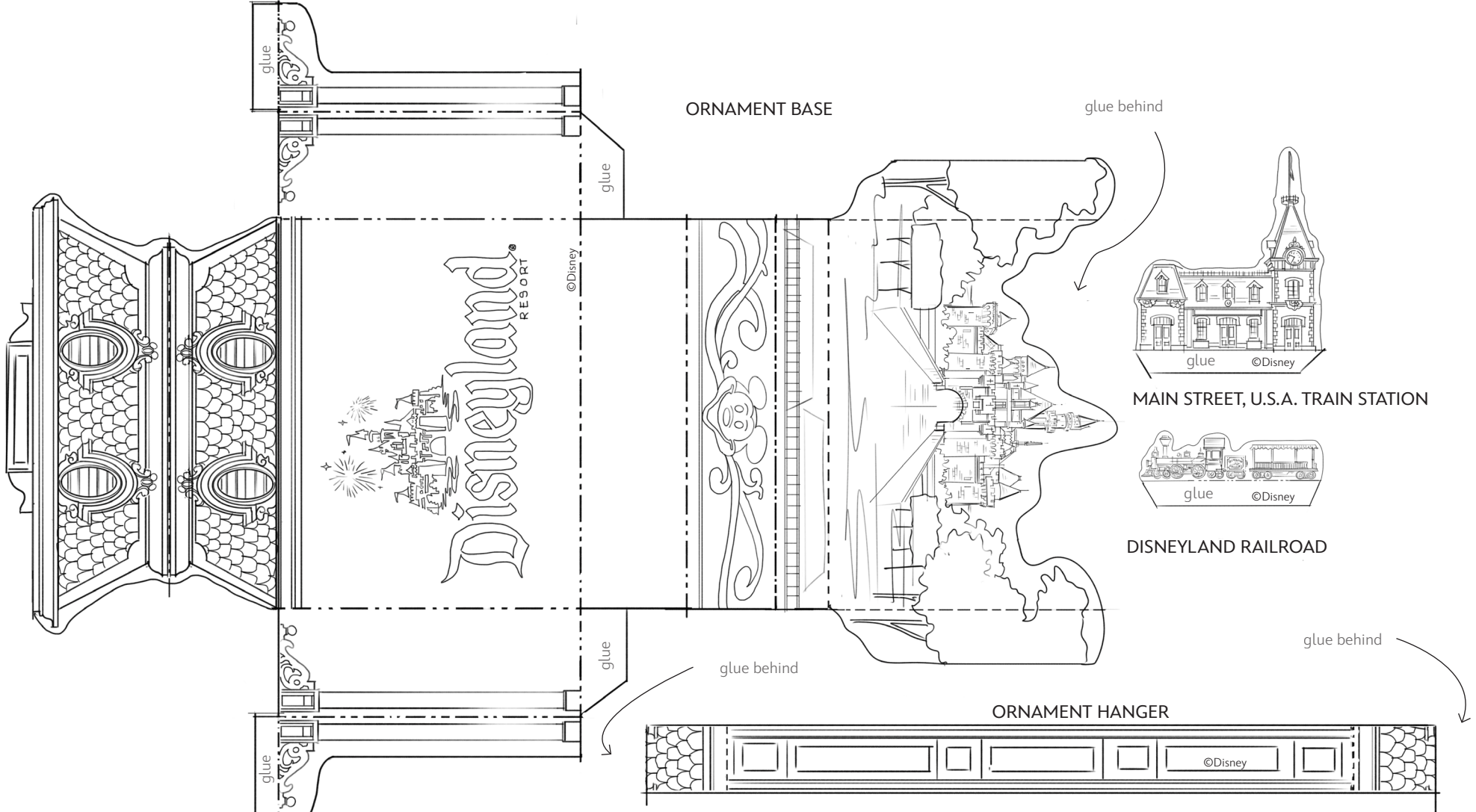

### MATERIALS



Glue



Scissors



Crayons

### INSTRUCTIONS

1. Color the page however you'd like!
2. Cut along solid lines where indicated.
3. Fold tabs and pieces according to Guide.
4. Glue the Train Station behind the tracks, towards one side. Glue the Train on the tracks, towards the opposite side.
5. Glue the ornament hanger on the roof, as indicated.

----- Valley fold, fold in front

..... Mountain fold, fold behind

————— Cut





# Disney Paper Parks

#DisneyMagicMoments | #DisneyPaperParks

## DAY 2: DISNEY CALIFORNIA ADVENTURE

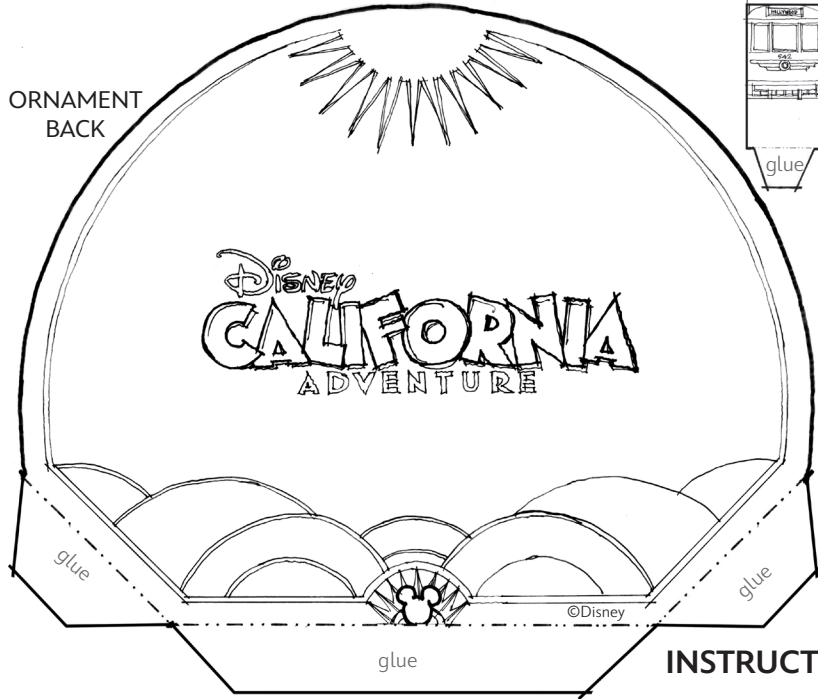

ORNAMENT BACK

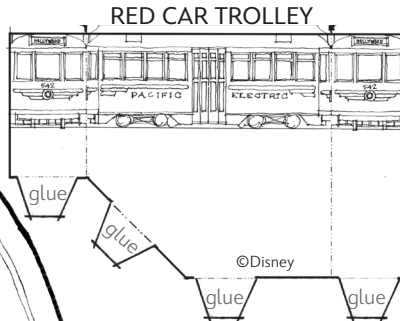

RED CAR TROLLEY



TOP TAB

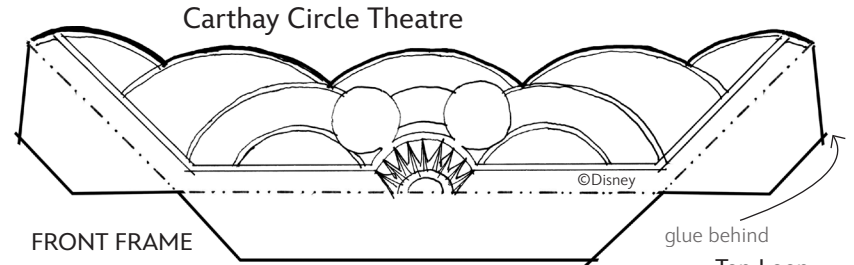

Carthay Circle Theatre

FRONT FRAME

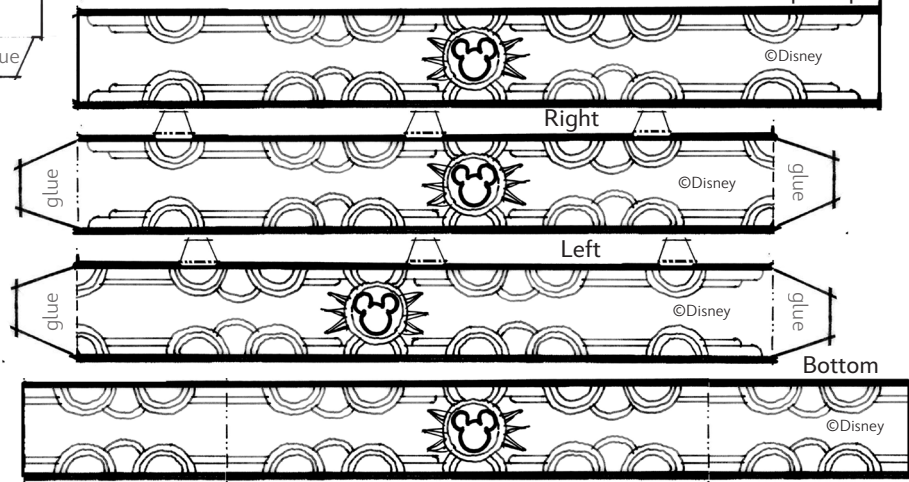

Top Loop

Right

Left

Bottom

### INSTRUCTIONS

1. Color the page however you'd like!
2. Cut along solid lines where indicated.
3. Fold tabs and pieces according to Guide.
4. Glue the Background to the Ornament Back. Glue Carthay Circle Theatre to the bottom right corner of the ornament, in front of the Background.
5. Align the Trolley with Carthay Circle Theatre and glue the tabs down on the bottom left corner of the ornament.
6. Carefully glue the Left and Right Borders to the ornament, placing the tabs at the back. Then glue the Bottom Border and, using the tabs, glue the Top Loop.
7. Finally, glue the Top Tab, hanging down below the loop.

### MATERIALS

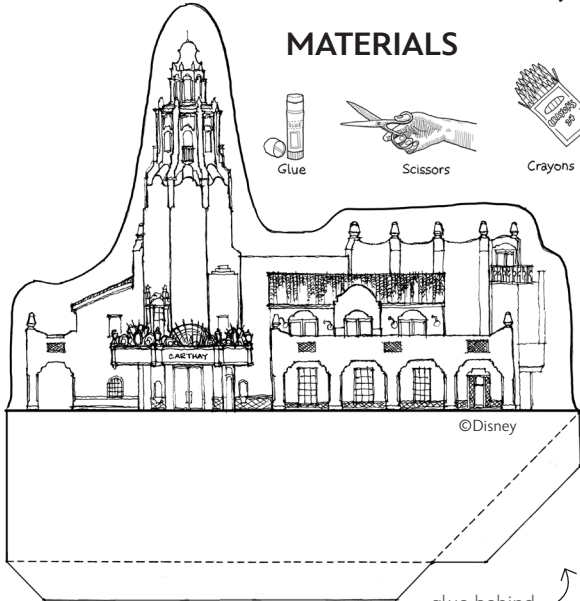
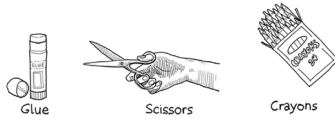

CARTHAY CIRCLE THEATRE

glue behind

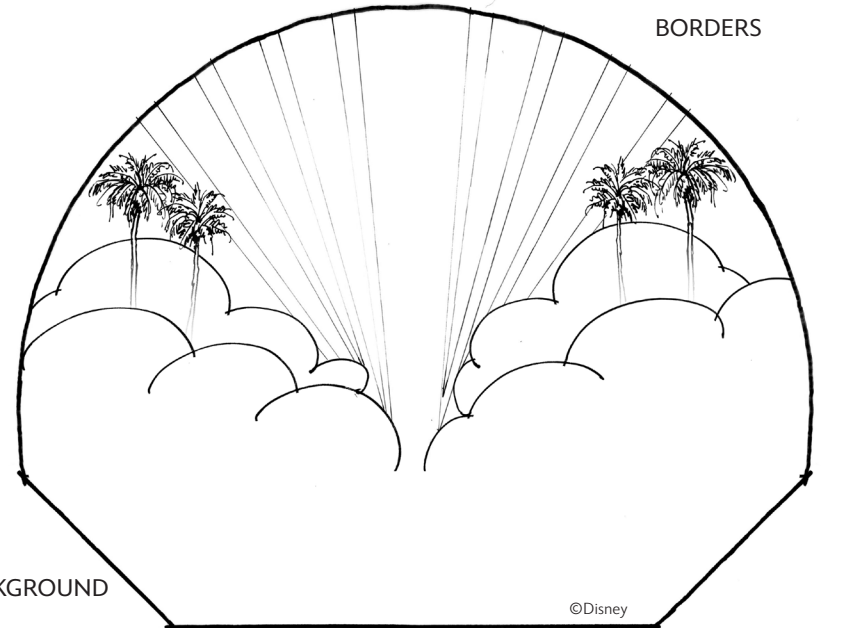

BORDERS

BACKGROUND





# Disney Paper Parks

#DisneyMagicMoments | #DisneyPaperParks

## DAY 4: EPCOT

Spaceship Earth and World Showcase

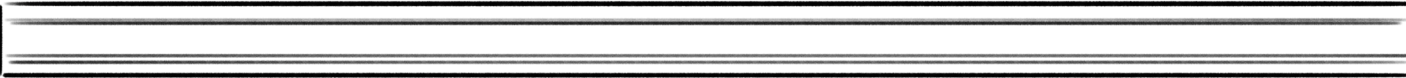

ORNAMENT HANGER

ORNAMENT EDGE

glue all tabs

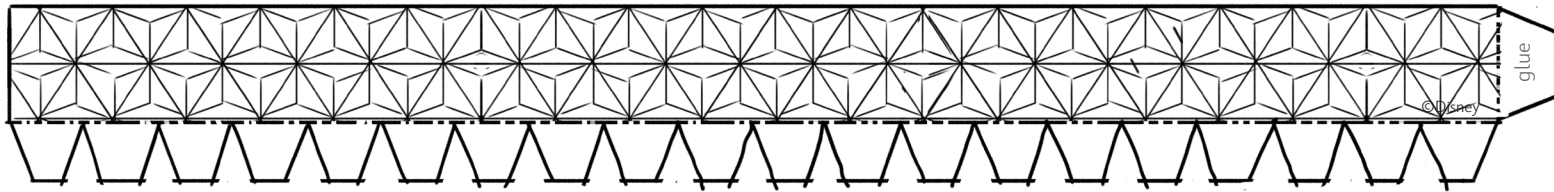

©Disney

ORNAMENT BACK

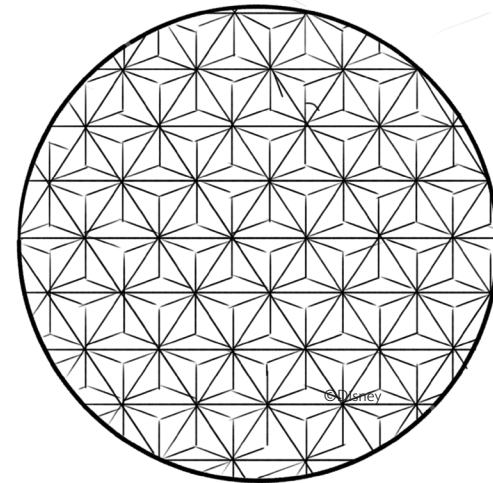

©Disney

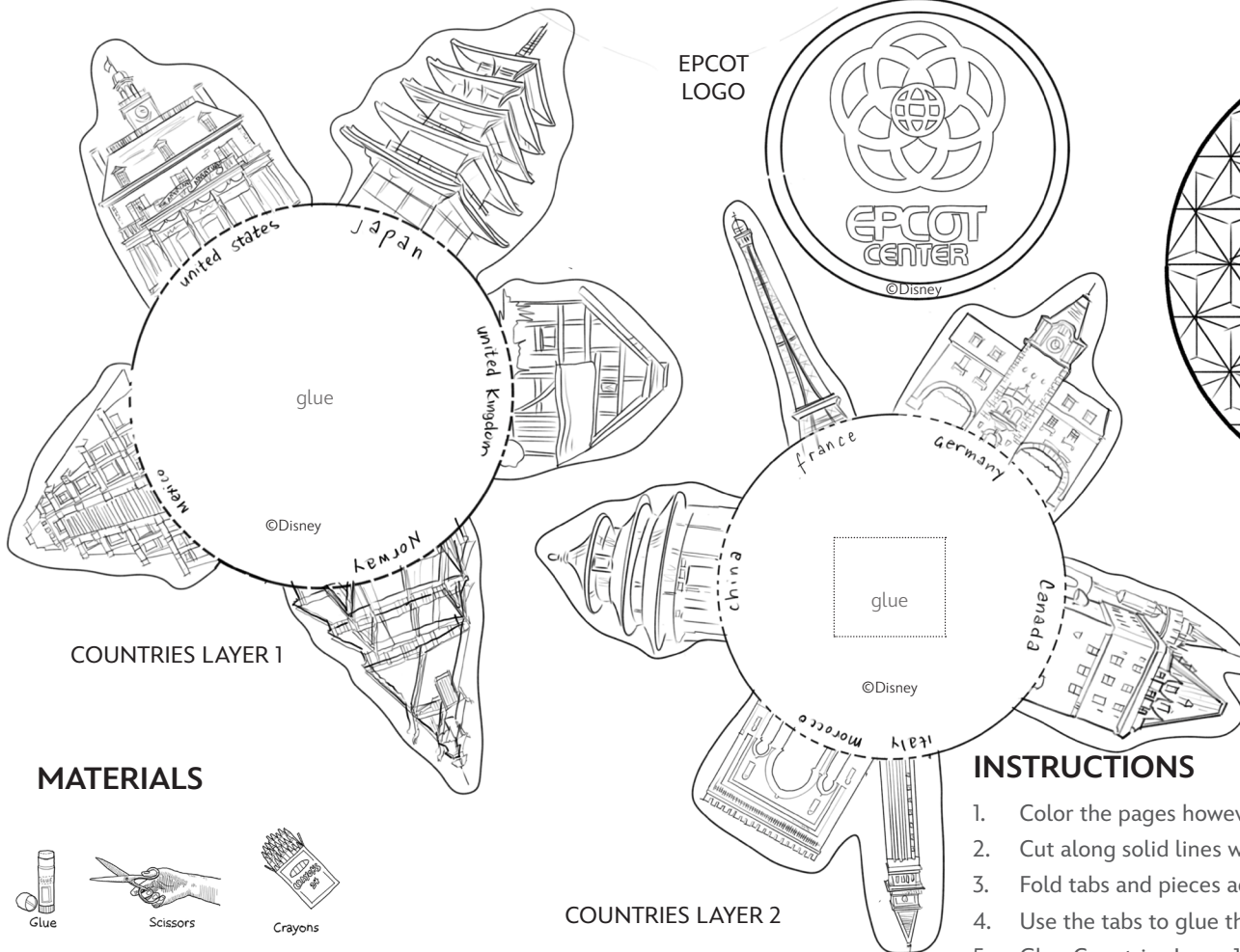

EPCOT LOGO

EPCOT CENTER

©Disney

©Disney

©Disney

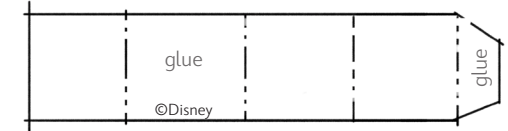

SPACER

### MATERIALS

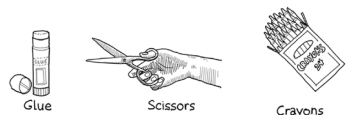

### INSTRUCTIONS

1. Color the pages however you'd like!
2. Cut along solid lines where indicated.
3. Fold tabs and pieces according to Guide.
4. Use the tabs to glue the Ornament Back to the Ornament Edge.
5. Glue Countries Layer 1 to the interior. Add Countries Layer 2 on top, then the spacer, and finally the EPCOT Logo. Glue Ornament Hanger on Back as a loop.

----- Valley fold, fold in front

..... Mountain fold, fold behind

\_\_\_\_\_ Cut





# Disney Paper Parks

#DisneyMagicMoments | #DisneyPaperParks

## DAY 5: DISNEY'S HOLLYWOOD STUDIOS

### 50's Prime Time Cafe

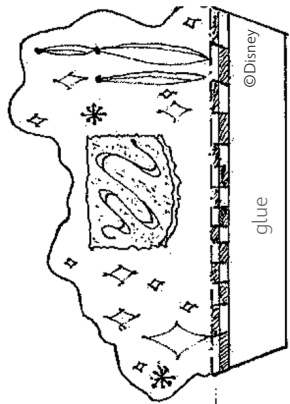

MOM'S MEAT LOAF

SIGNAGE

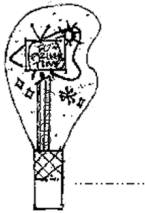

MOON

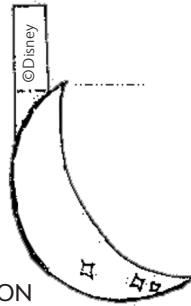

FACADE

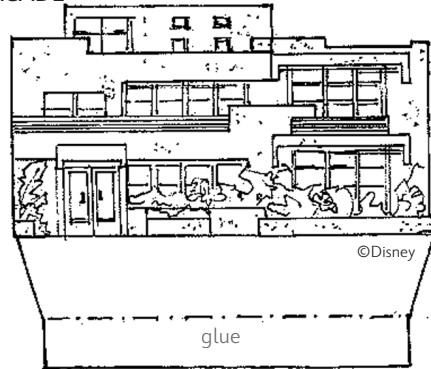

GARDEN

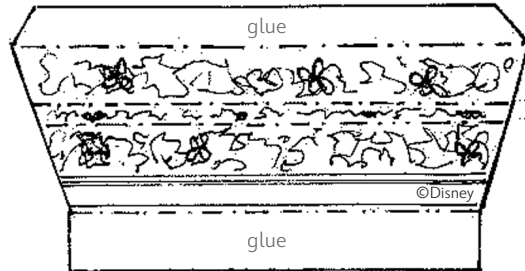

ORNAMENT BASE

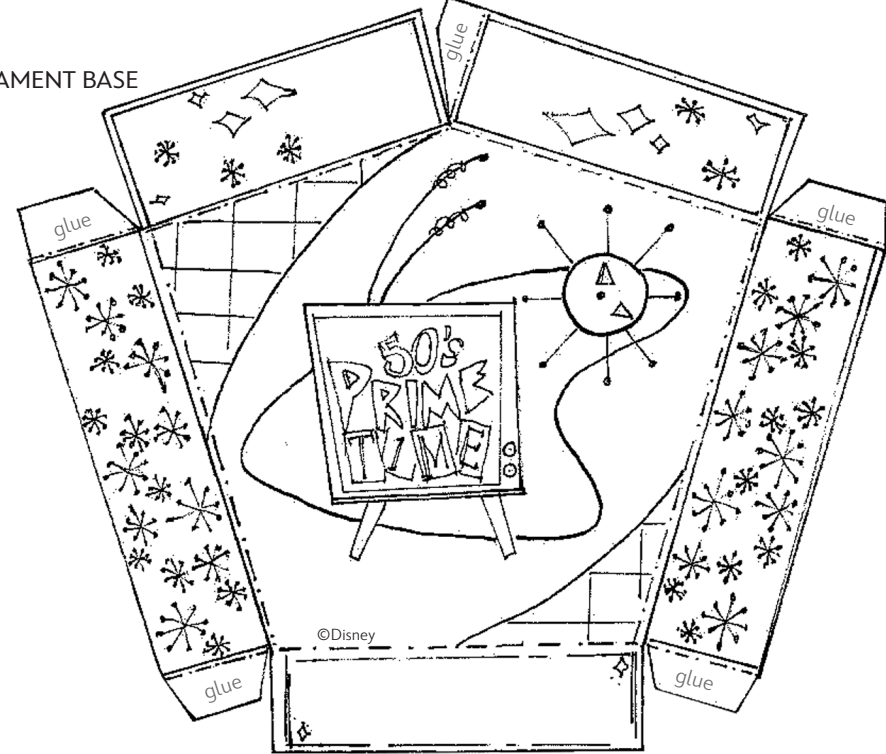

ORNAMENT BACK

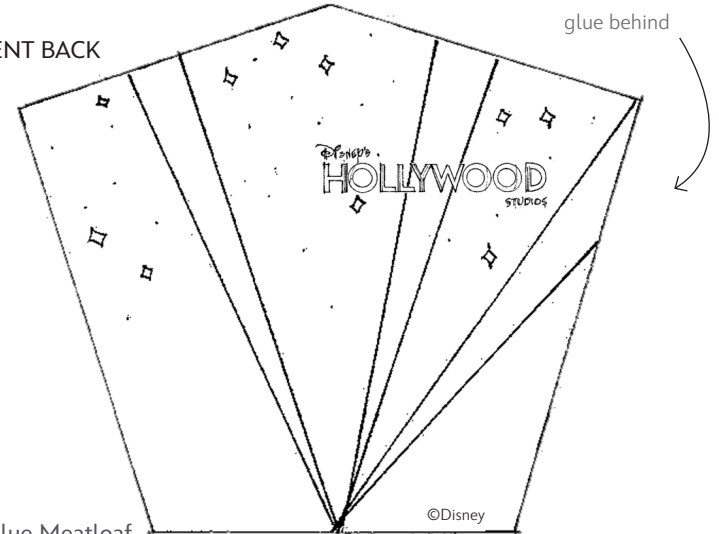

### MATERIALS



Glue



Scissors



Crayons

### INSTRUCTIONS

1. Color the page however you'd like!
2. Cut along solid lines where indicated.
3. Fold tabs and pieces according to Guide.
4. Construct ornament base. Glue Ornament Back to the inside backside. Glue Meatloaf to the bottom to hang down. Then glue the Garden to the bottom and the facade. Add moon above and signage below.

----- Valley fold, fold in front

..... Mountain fold, fold behind

————— Cut



# Disney Paper Parks

#DisneyMagicMoments | #DisneyPaperParks

## DAY 6: DISNEY'S ANIMAL KINGDOM

Park Icons



FLOATING MOUNTAINS OF PANDORA

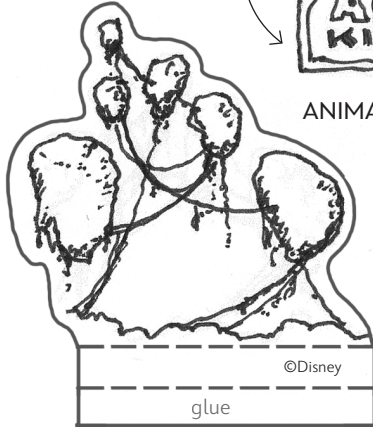

glue behind

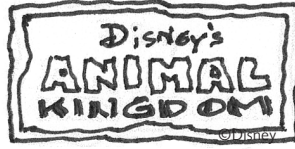

ANIMAL KINGDOM LOGO

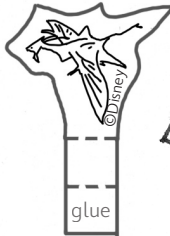

BANSHEE

ORNAMENT HANGER

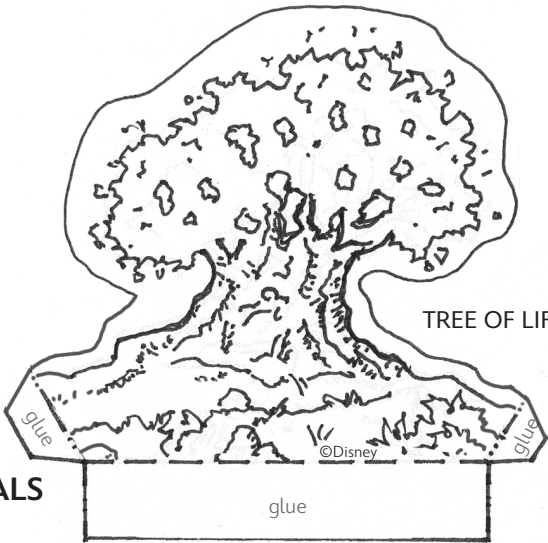

TREE OF LIFE

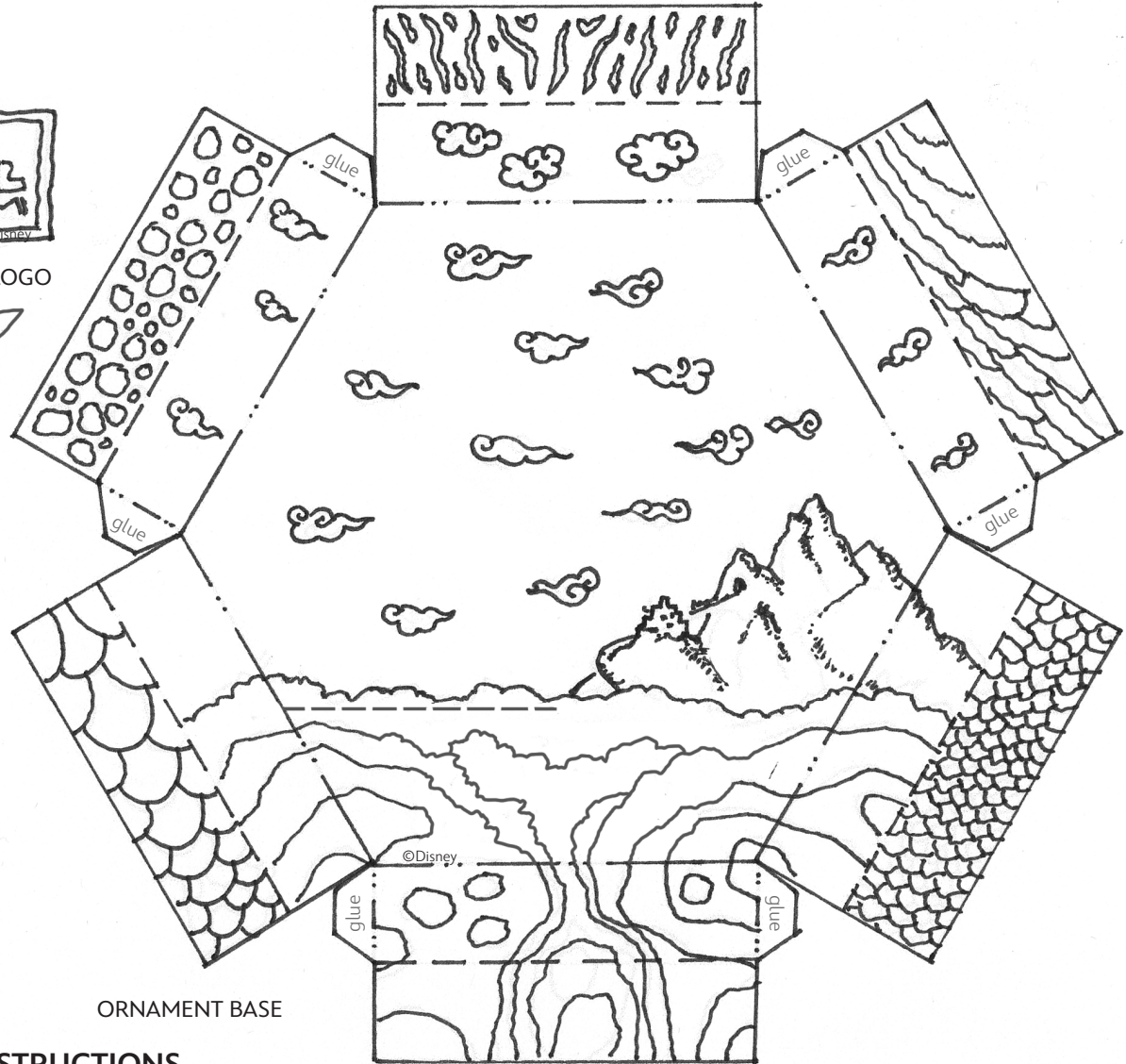

ORNAMENT BASE

### MATERIALS



### INSTRUCTIONS

1. Color the pages however you'd like!
2. Cut along solid lines where indicated.
3. Fold tabs and pieces according to Guide.
4. Construct the Ornament Base, remembering to fold the edges in.
5. Glue the Floating Mountains towards the back and add the Banshee on top
6. Glue the Tree of Life towards the front. Add Ornament Hanger.

----- Valley fold, fold in front

..... Mountain fold, fold behind

————— Cut



# Disney Paper Parks

#DisneyMagicMoments | #DisneyPaperParks

## DAY 7: DISNEYLAND PARIS

Le Château de la Belle au Bois Dormant

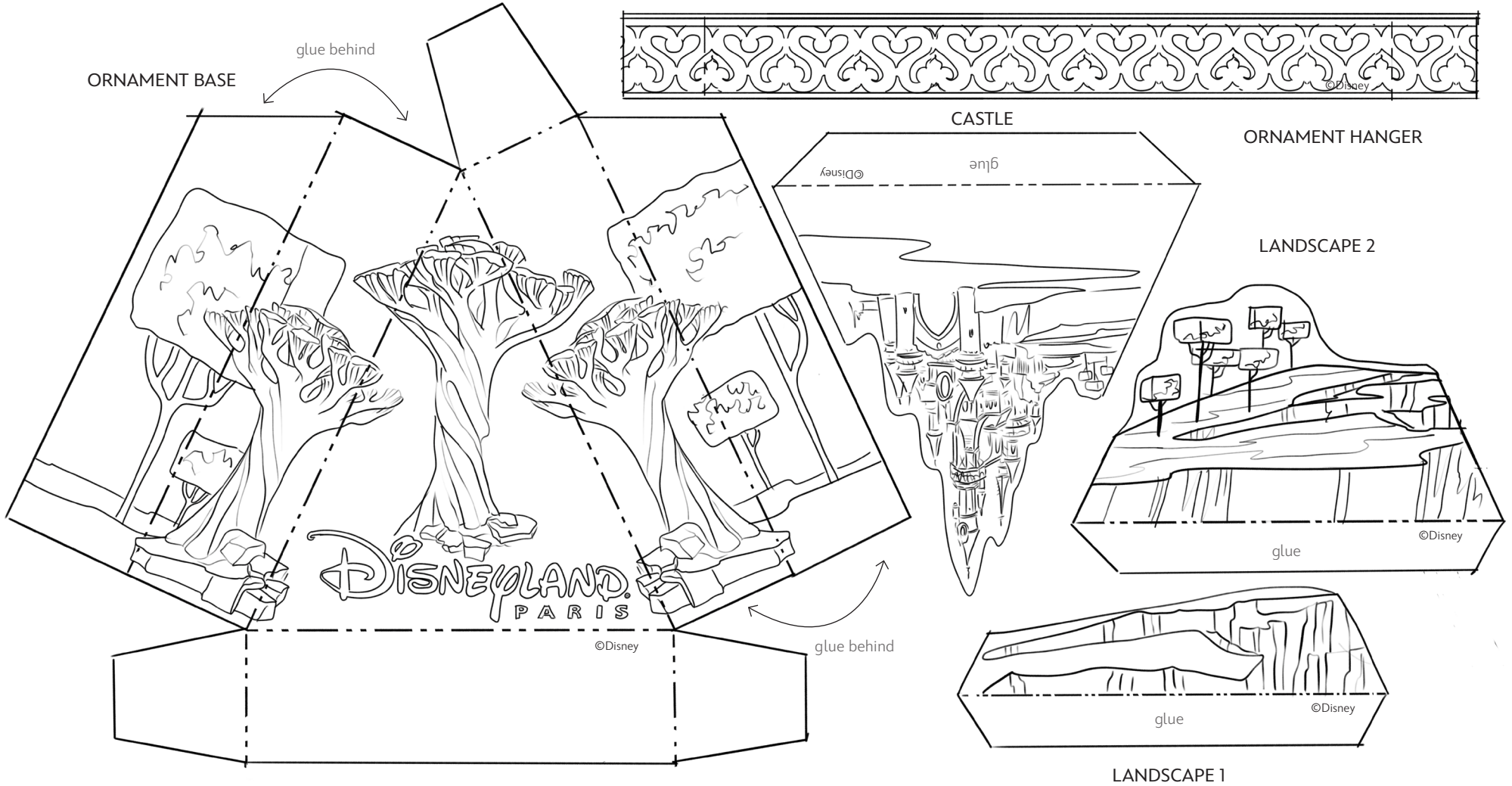

### MATERIALS



Glue



Scissors



Crayons

### INSTRUCTIONS

1. Color the page however you'd like!
2. Cut along solid lines where indicated.
3. Fold tabs and pieces according to Guide.
4. Construct Ornament Base. Be sure to fold the tabs between the folded sides.
5. From back to front, use the tabs to glue Castle, Landscape 2, then Landscape 1 to the bottom. Add Ornament Hanger on top.

----- Valley fold, fold in front

..... Mountain fold, fold behind

————— Cut





# Disney Paper Parks

#DisneyMagicMoments | #DisneyPaperParks

## DAY 8: WALT DISNEY STUDIOS PARK

Studio 1

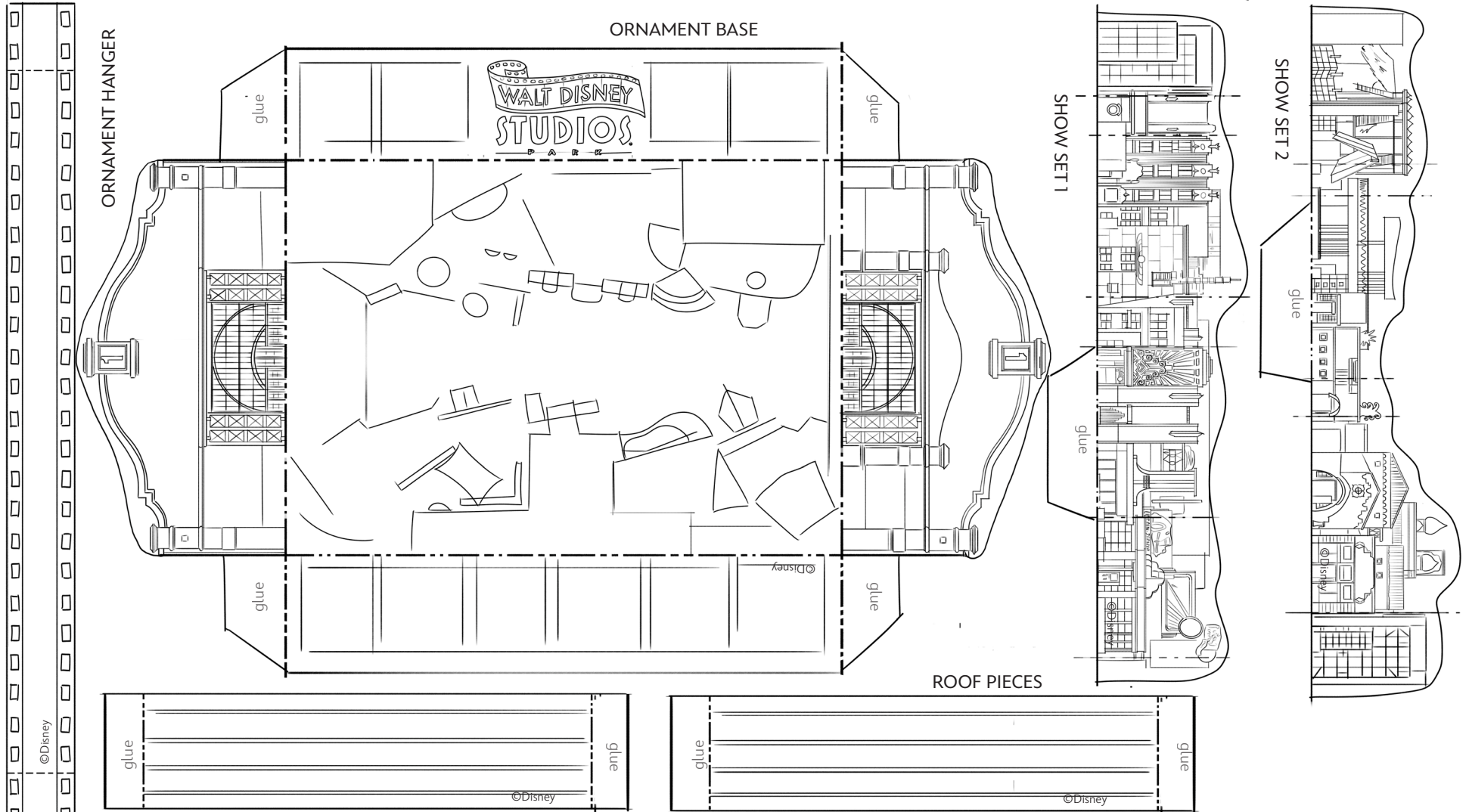

### MATERIALS

### INSTRUCTIONS



Glue



Scissors



Crayons

1. Color the page however you'd like!
2. Cut along solid lines where indicated.
3. Fold tabs and pieces according to Guide.
4. Construct the Ornament Base. Fold and glue Show Set 1 and 2 to create interior street (feel free to create your own spaces!)
5. Glue Roof Pieces on either end of the model. Keep a space in between to view inside. Glue Ornament Hanger to Roof Pieces.



# Disney Paper Parks

#DisneyMagicMoments | #DisneyPaperParks

## DAY 9: HONG KONG DISNEYLAND

### Mystic Manor

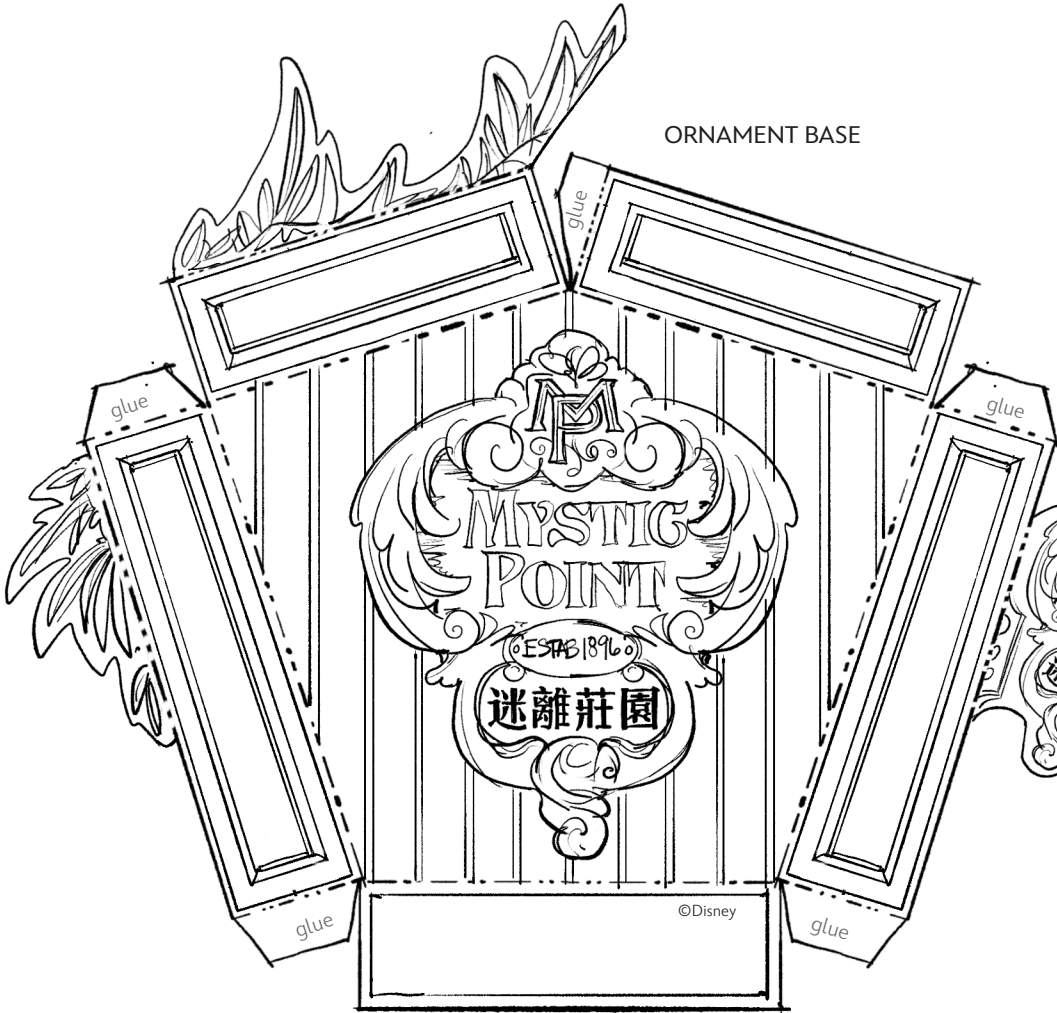

ORNAMENT BASE

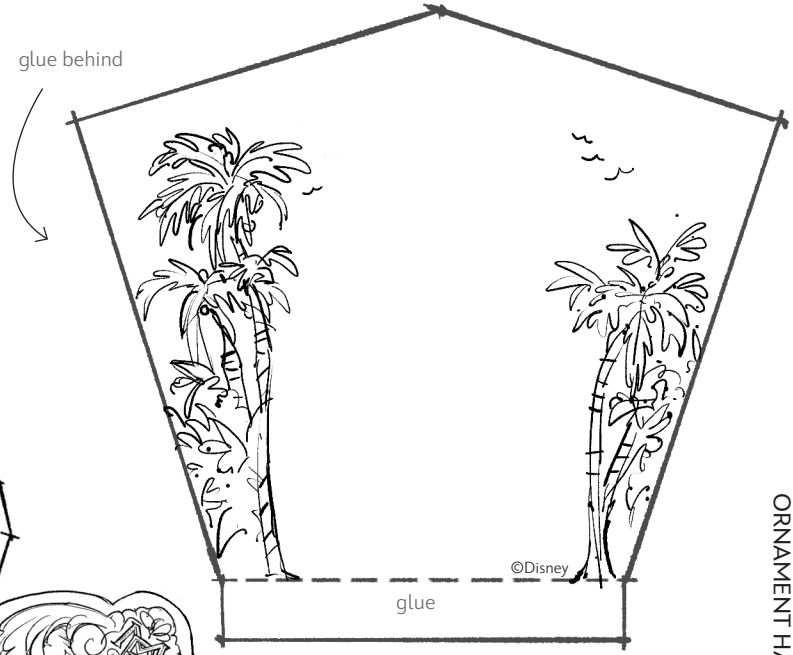

ORNAMENT BACK

ORNAMENT HANGER

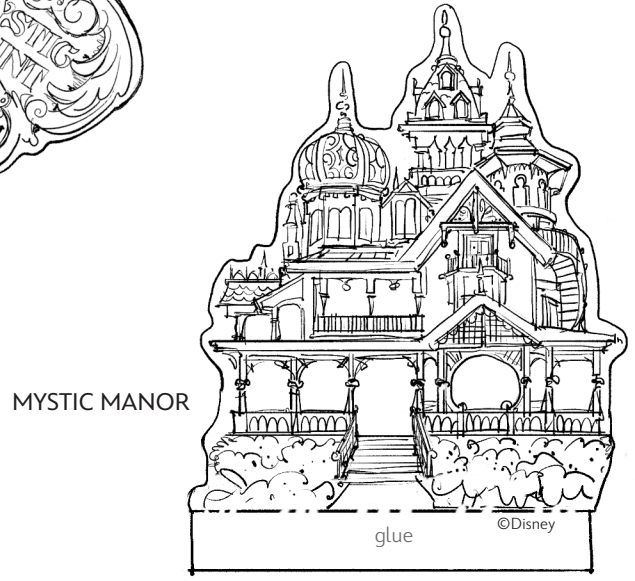

MYSTIC MANOR



©Disney

### MATERIALS



Glue



Scissors



Crayons

### INSTRUCTIONS

1. Color the page however you'd like!
2. Cut along solid lines where indicated.
3. Fold tabs and pieces according to Guide.
4. Construct the ornament base. Then glue the background to the inside backside.
5. Glue Mystic Manor to the bottom of the inside of the ornament. Glue the Ornament Hanger on the top.

----- Valley fold, fold in front

..... Mountain fold, fold behind

————— Cut



# Disney Paper Parks

#DisneyMagicMoments | #DisneyPaperParks

## DAY 10: TOKYO DISNEYLAND

### Main Gate

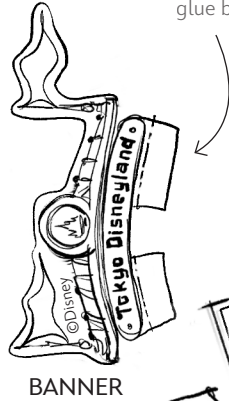
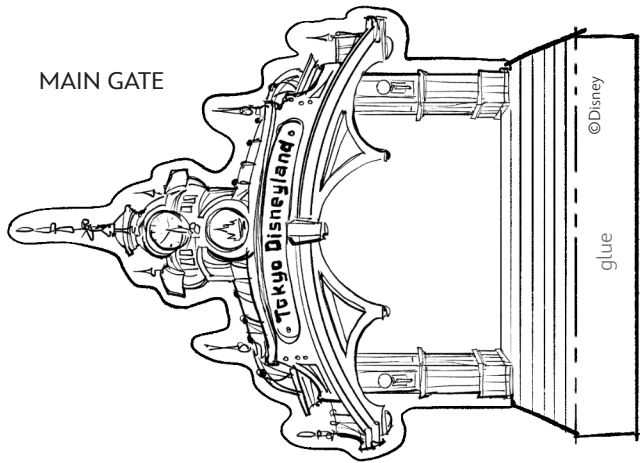

glue behind

### ORNAMENT BASE

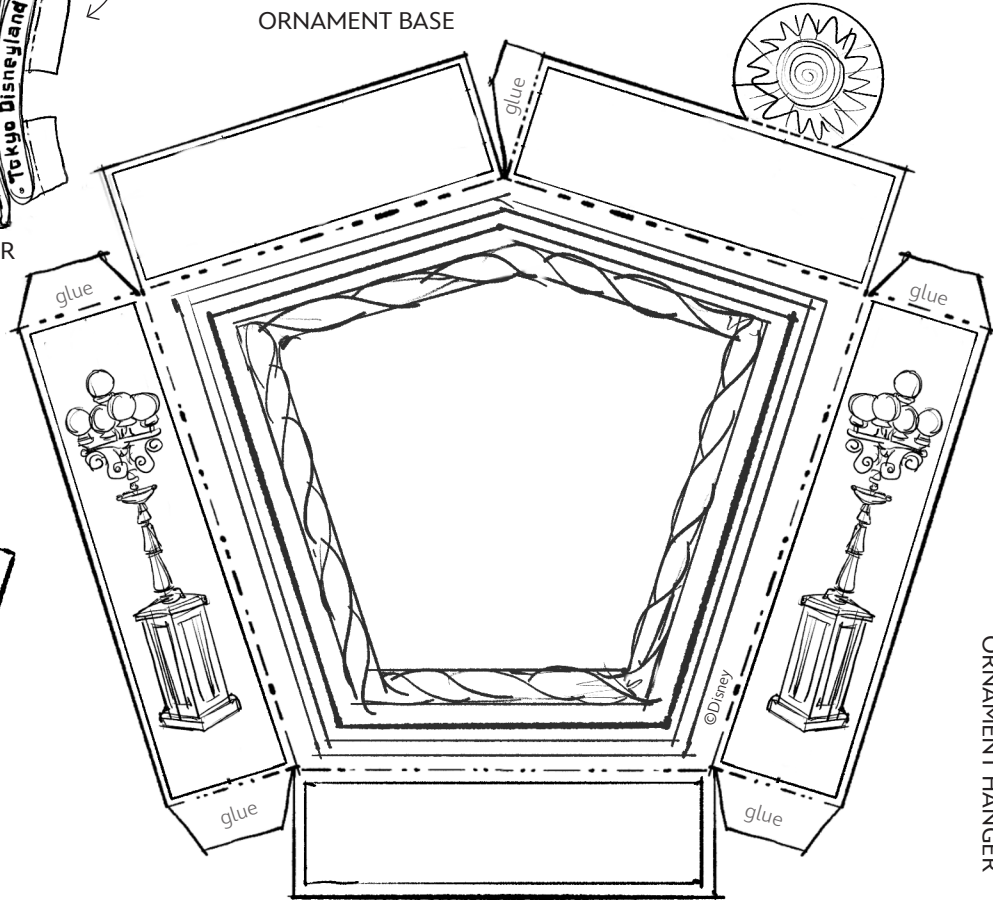

glue behind

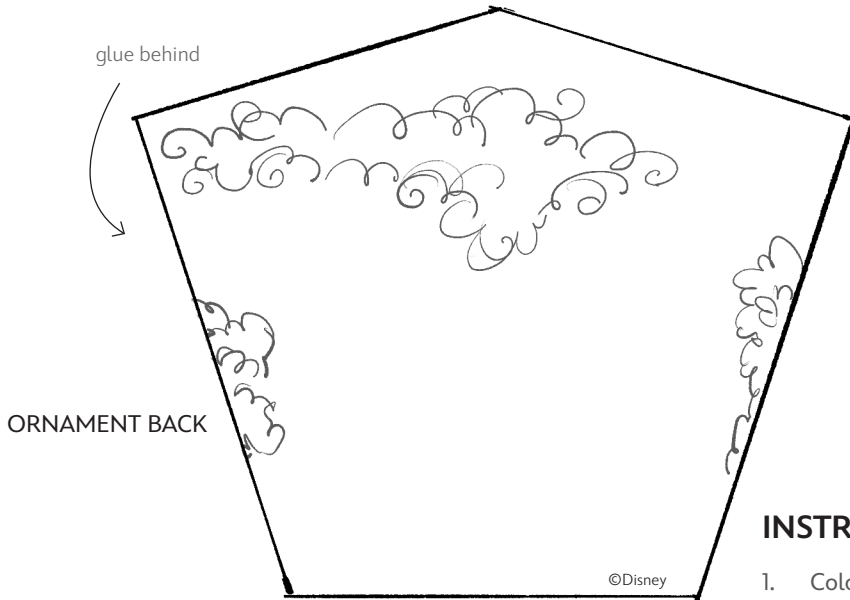

### ORNAMENT BACK

## MATERIALS

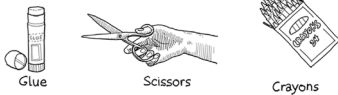

## INSTRUCTIONS

1. Color the page however you'd like!
2. Cut along solid lines where indicated.
3. Fold tabs and pieces according to Guide.
4. Construct the ornament base. Then glue the background to the inside backside.
5. Glue to Main Gate to the inside bottom of the Ornament Base.
6. Glue the Banner to the back of the Ornament Base. Attach Ornament Hanger.





# Disney Paper Parks

#DisneyMagicMoments | #DisneyPaperParks

## DAY 11: TOKYO DISNEYSEA

### Mount Prometheus

ORNAMENT HANGER

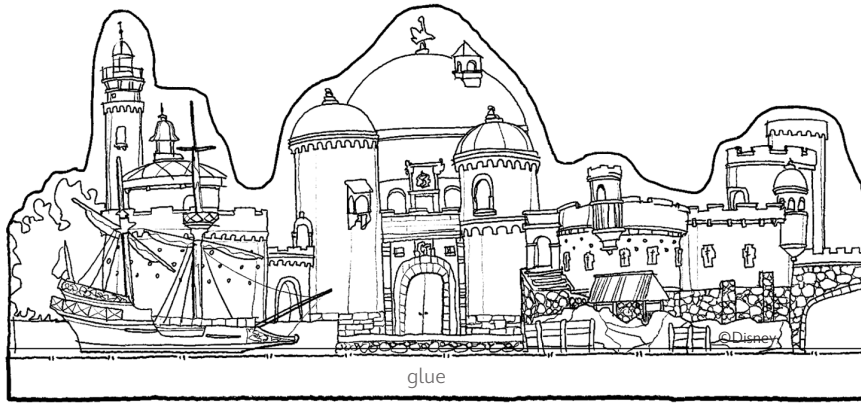

FORTRESS

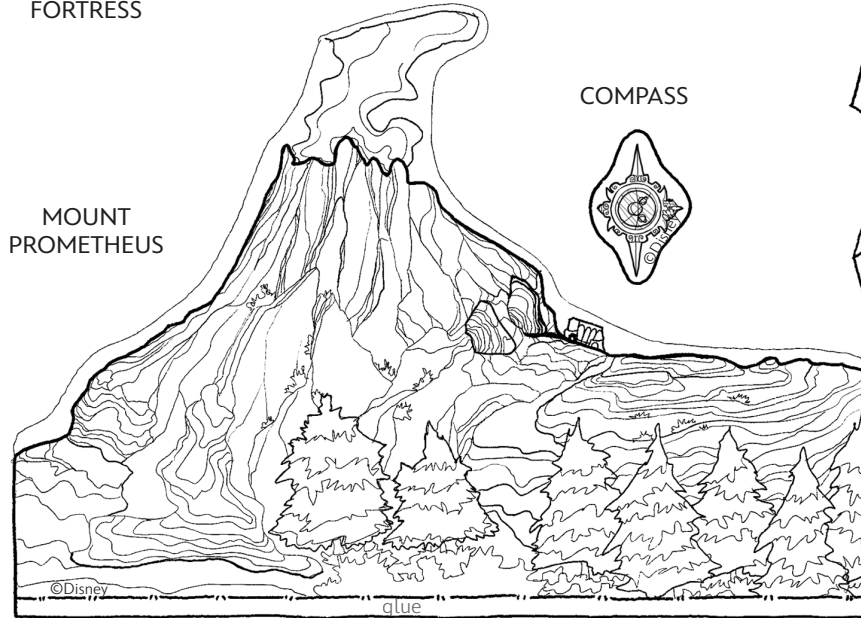

MOUNT PROMETHEUS

COMPASS

ORNAMENT BASE

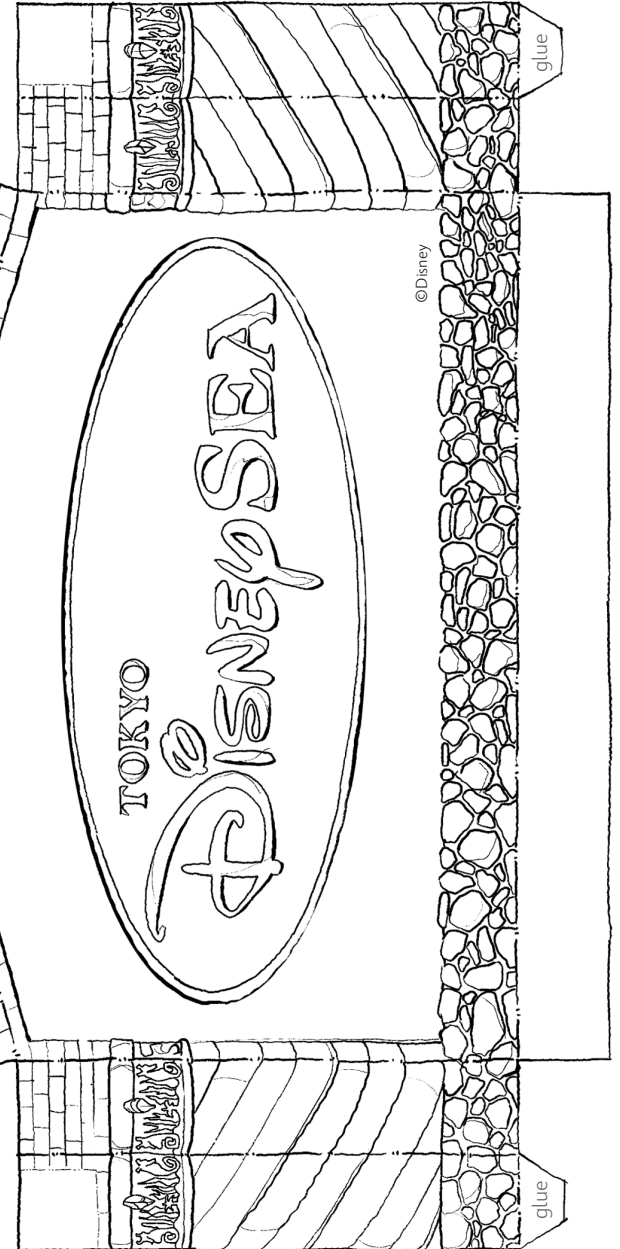

### MATERIALS



Glue



Scissors



Crayons

### INSTRUCTIONS

1. Color the page however you'd like!
2. Cut along solid lines where indicated.
3. Fold tabs and pieces according to Guide.
4. Construct the ornament base. Glue the Compass at the seam.
5. Glue Mount Prometheus towards the back and the Fortress toward the front. Glue the Ornament Hanger on the top.

----- Valley fold, fold in front

..... Mountain fold, fold behind

————— Cut

