

Disney Parks Blog

presents:

Disney Paper Parks

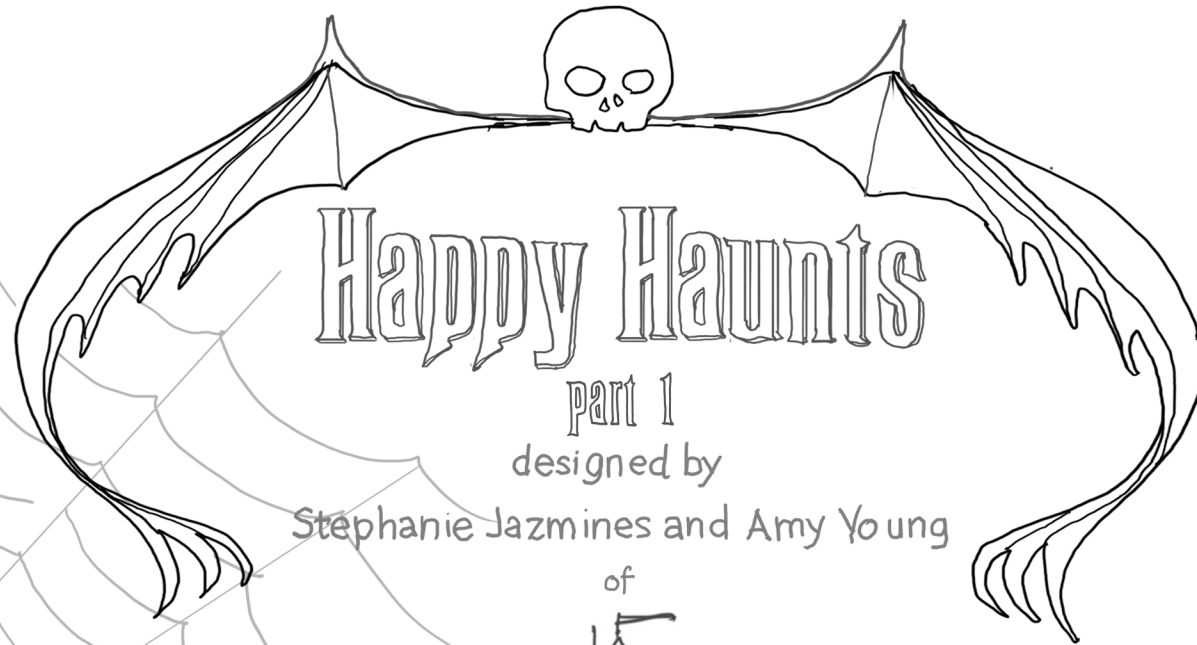

Happy Haunts

part 1

designed by

Stephanie Jazmines and Amy Young

of



Walt Disney IMAGINEERING
© Disney

#DisneyMagicMoments | #DisneyPaperParks



Disney Paper Parks

#DisneyMagicMoments | #DisneyPaperParks

DISNEYLAND ENTRY GATES

Sheet Numbers: 1A, 1B, 1C, 2A, 2B, 2C, 3 & 4

HISTORY

Nothing signifies the beginning of a Disneyland day like walking through the turnstiles under the Main Gate pavilions.

Traditionally, the gates are adorned with giant pumpkins for Halloween. Each one is an artistic endeavor involving hours of carving, sanding, finishing, and painting to bring the Fab 5 to life in pumpkin form.

Welcome, Foolish Mortals, to
Disney Paper Parks: Happy Haunts Edition.

MATERIALS



Glue



Scissors



Crayons

GUIDE

Lines

- Valley fold, fold in front
- - - - - Mountain fold, fold behind
- Cut
- X-ray or guide line.

INSTRUCTIONS

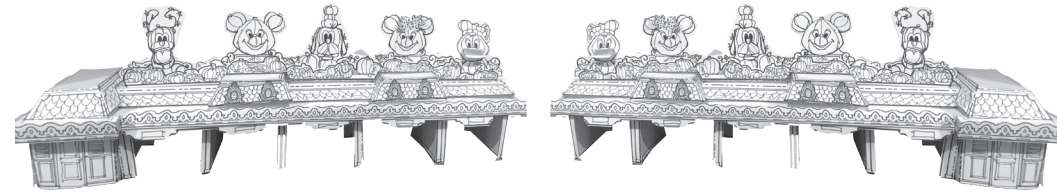

1. Color all the sheets as you like.
2. Cut out all pieces from Sheet 1A / 2A. Note: Since these are a pair, sheets 1A, 1B, and 1C are the same as 2A, 2B, and 2C. The instructions will be the same for both.
3. For the ceiling piece, fold all edges down and apply glue to the corners. Use the trip detail to wrap the edges, ensuring that they line up with the bottom and stick up over the top. Set aside.
4. Cut out all pieces from sheet 1B / 2B. Fold along the lines and glue the edges. Apply drops of glue to adhere the corners of the long roof to the ceiling piece. Using the labels as guides, place the small roofs on the long roof and glue the tabs to the ceiling piece to secure.
5. Cut out all pieces on sheet 1C / 2C. Fold and glue as indicated. Use the guidelines on the ceiling to help place the gates. Glue the tops of the gates to the bottom of the ceiling.
6. Cut out the pieces on sheets 3 & 4. Tip for the small crown: to make the inside cuts easier, fold along the lines first, then cut the diagonal lines, unfold, and cut the rest out. If you would like to swap out the decorations in the future, we recommend using tape instead of glue.
7. For the larger pumpkins: fold and glue the tops together. Add the duck bills. Glue onto the roof. Your entry gates are now complete!

Please Note: When cutting with scissors and working with any of the materials listed above, adult participation and supervision is recommended.



Disney Paper Parks

#DisneyMagicMoments | #DisneyPaperParks

DISNEYLAND ENTRY GATES

Sheet Number: 1A

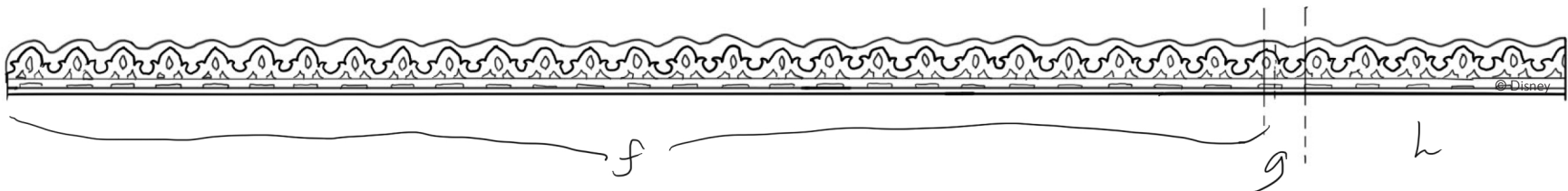
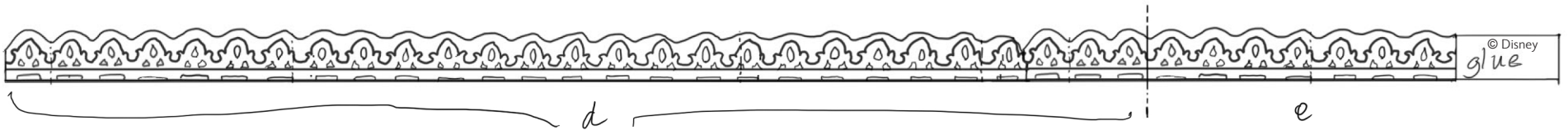
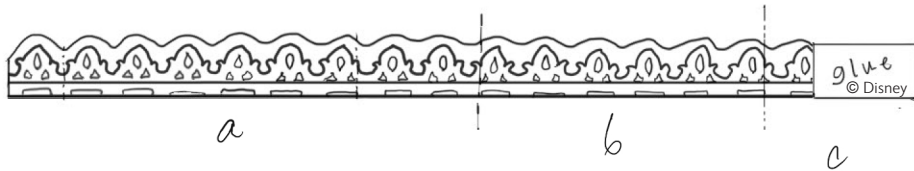
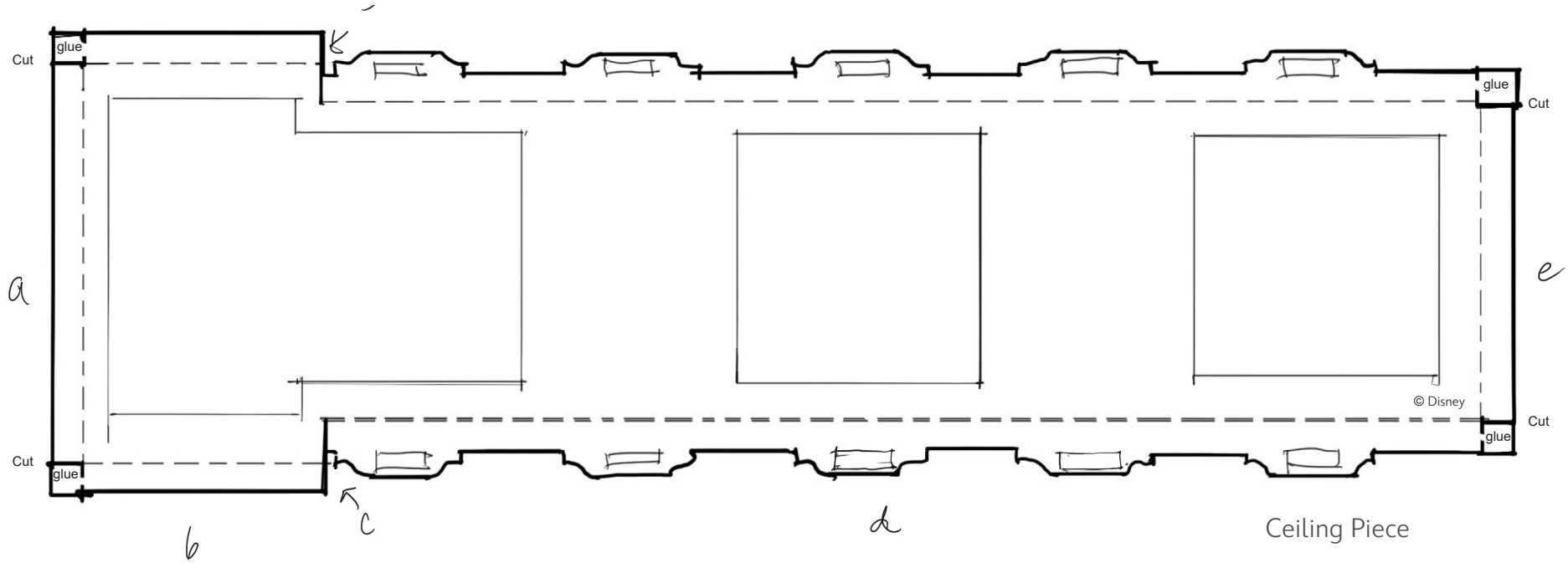



Disney Paper Parks

#DisneyMagicMoments | #DisneyPaperParks

DISNEYLAND ENTRY GATES

Sheet Number: 2A

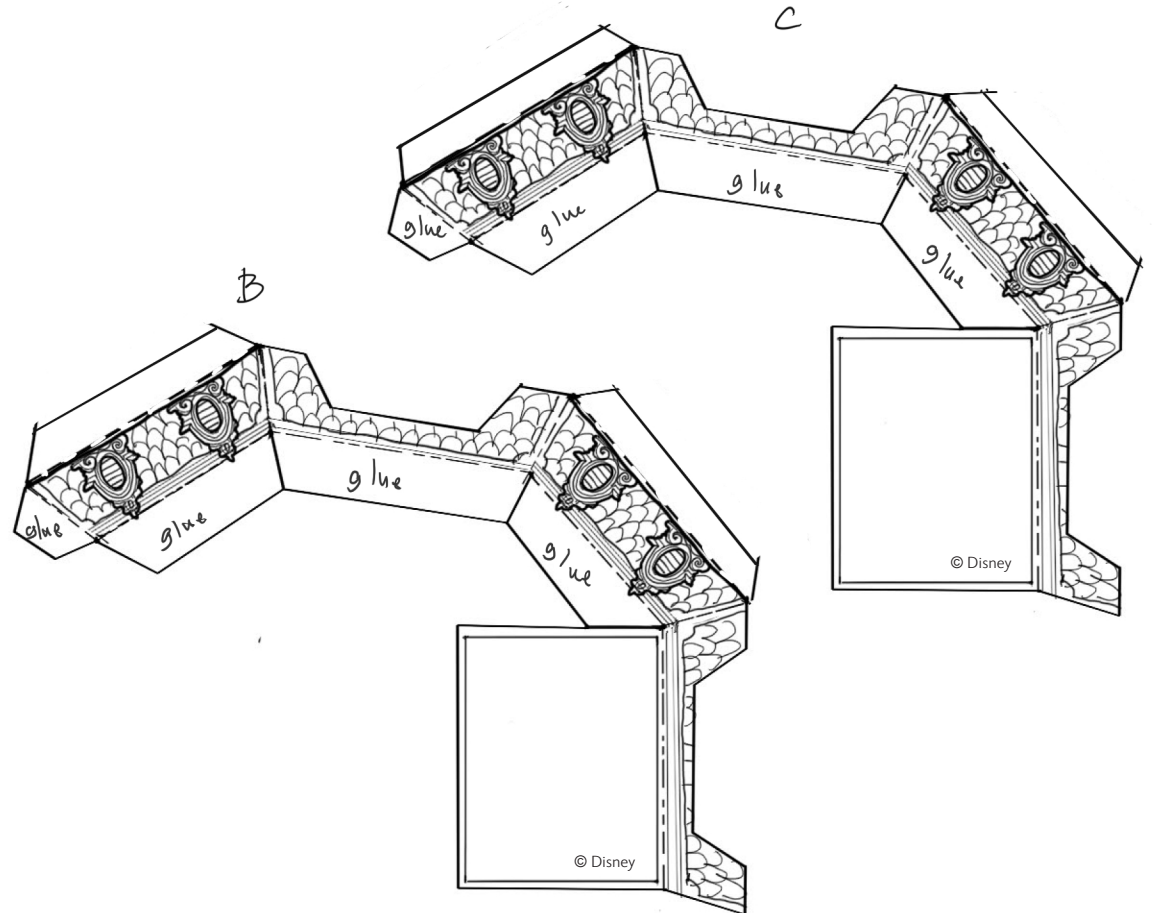
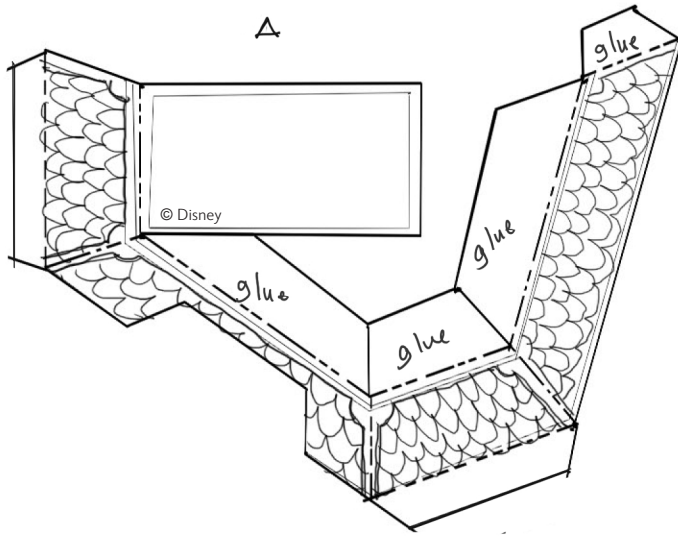
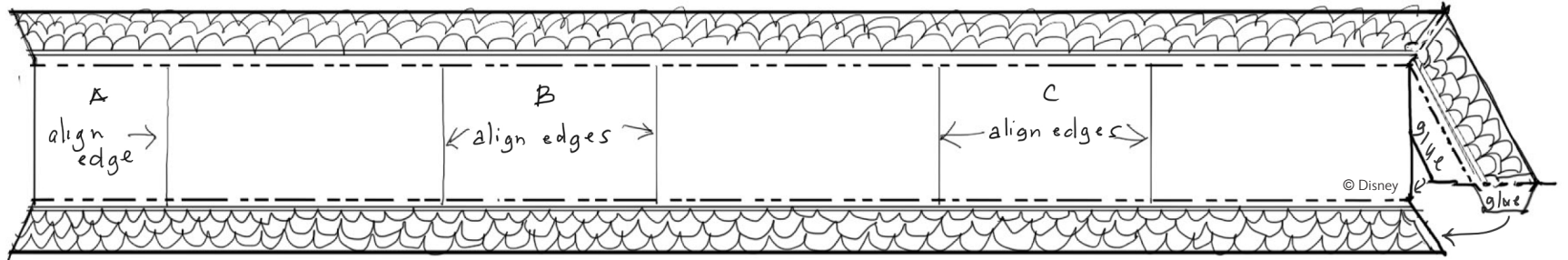



Disney Paper Parks

#DisneyMagicMoments | #DisneyPaperParks

DISNEYLAND ENTRY GATES

Sheet Number: 3A

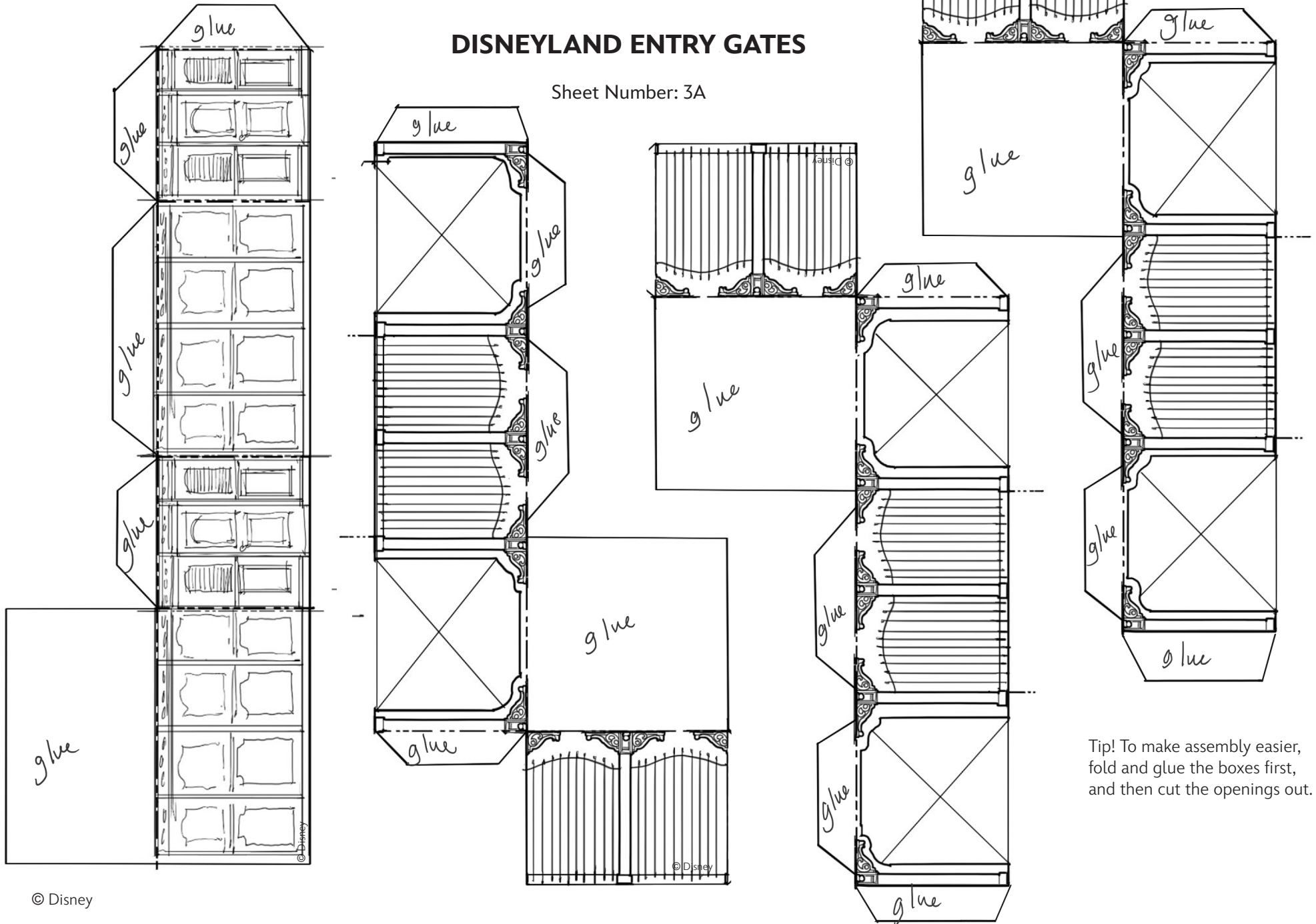

Tip! To make assembly easier, fold and glue the boxes first, and then cut the openings out.



Disney Paper Parks

#DisneyMagicMoments | #DisneyPaperParks

DISNEYLAND ENTRY GATES

Sheet Number: 2A

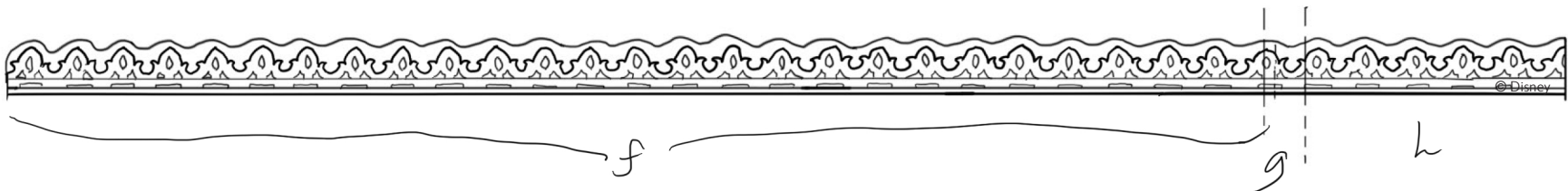
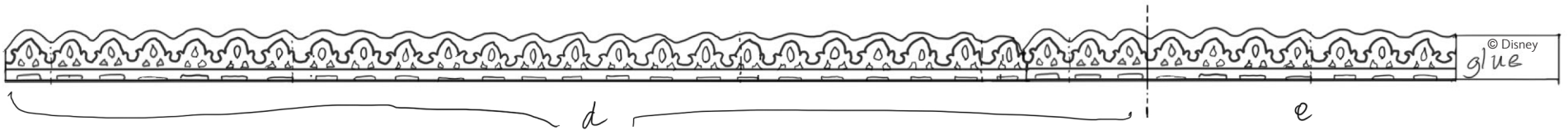
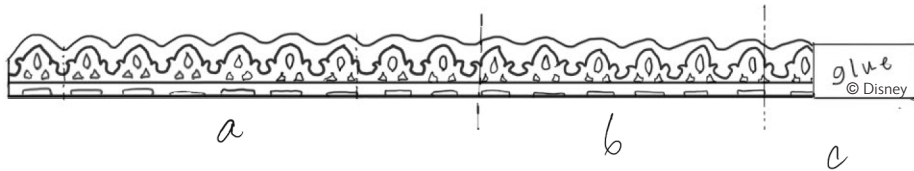
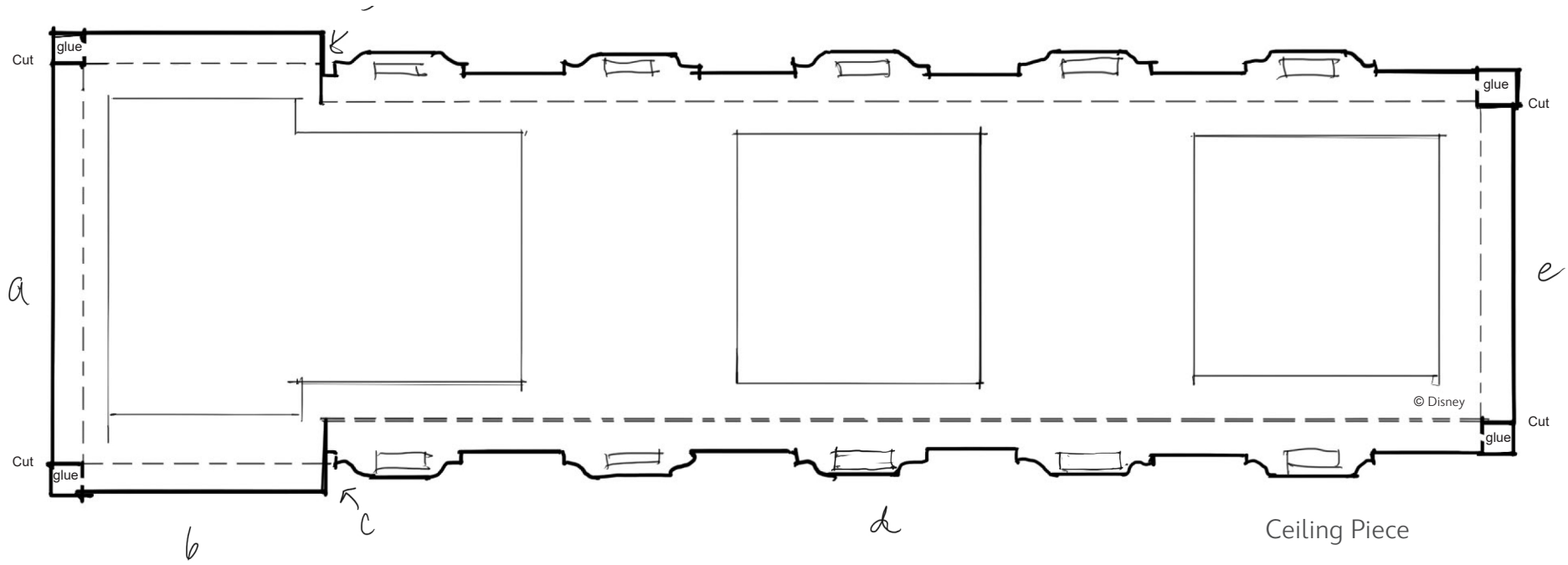



Disney Paper Parks

#DisneyMagicMoments | #DisneyPaperParks

DISNEYLAND ENTRY GATES

Sheet Number: 2B

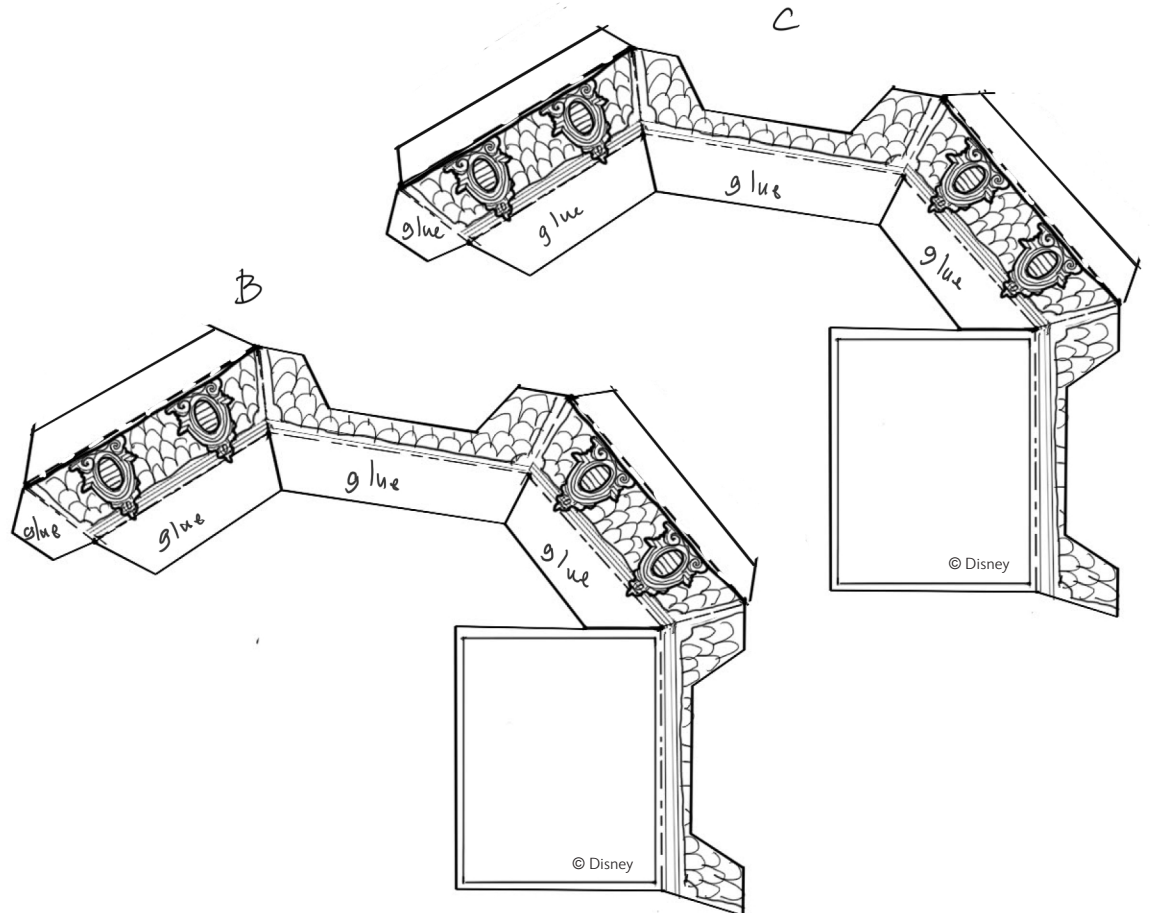
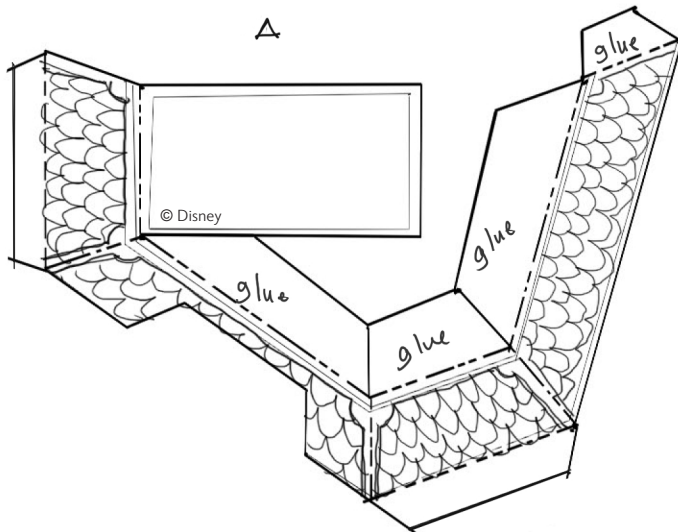
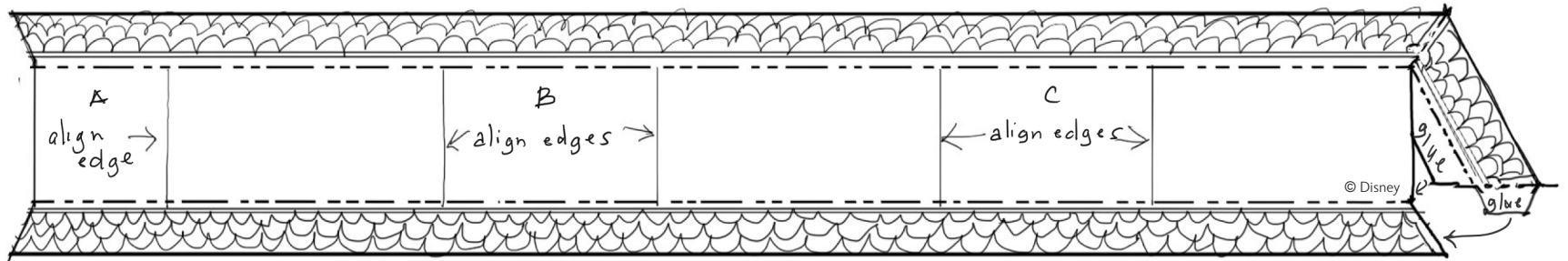



Disney Paper Parks

#DisneyMagicMoments | #DisneyPaperParks

DISNEYLAND ENTRY GATES

Sheet Number: 2C

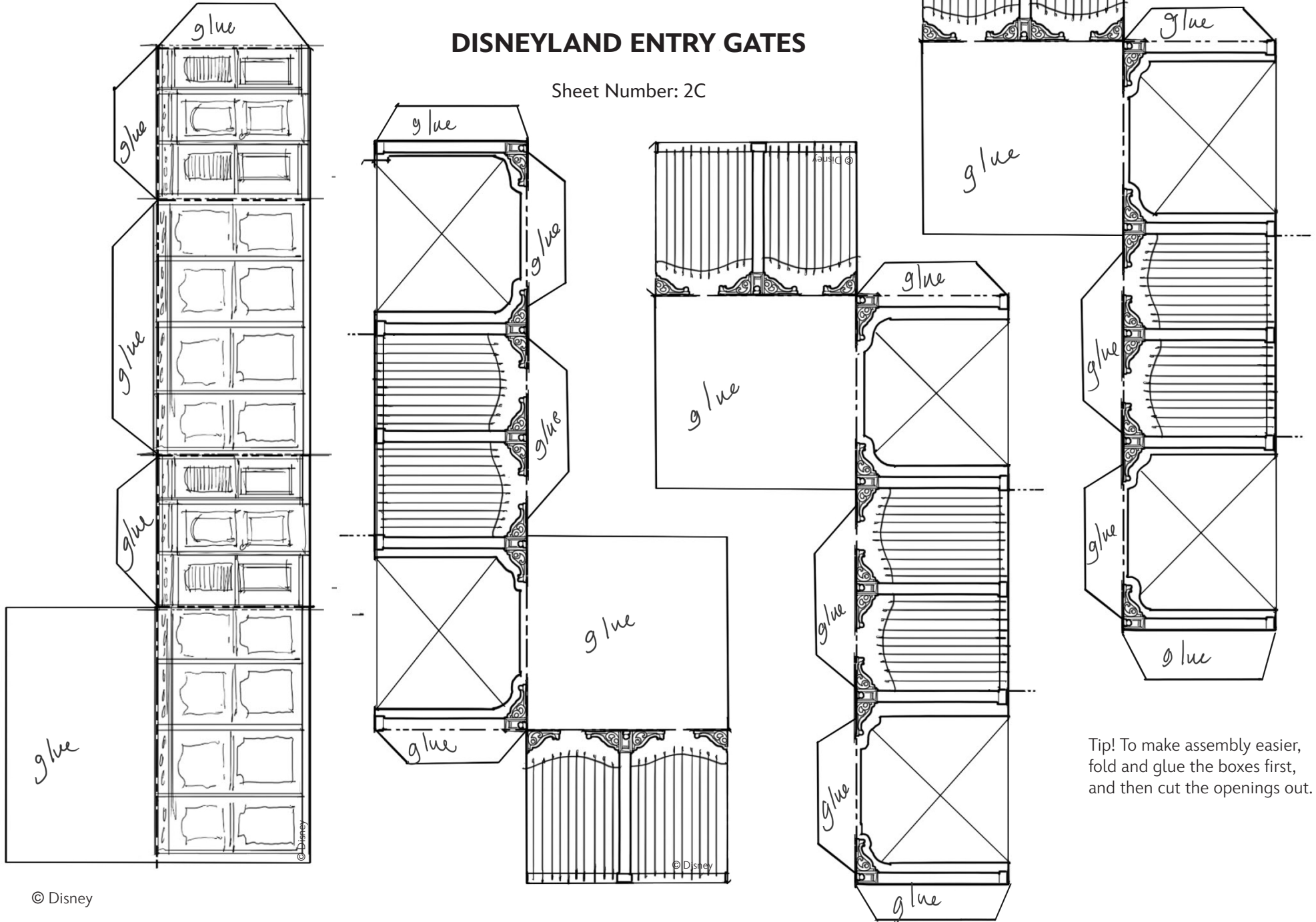

Tip! To make assembly easier, fold and glue the boxes first, and then cut the openings out.



Disney Paper Parks

#DisneyMagicMoments | #DisneyPaperParks

DISNEYLAND ENTRY GATES

Sheet Number: 3

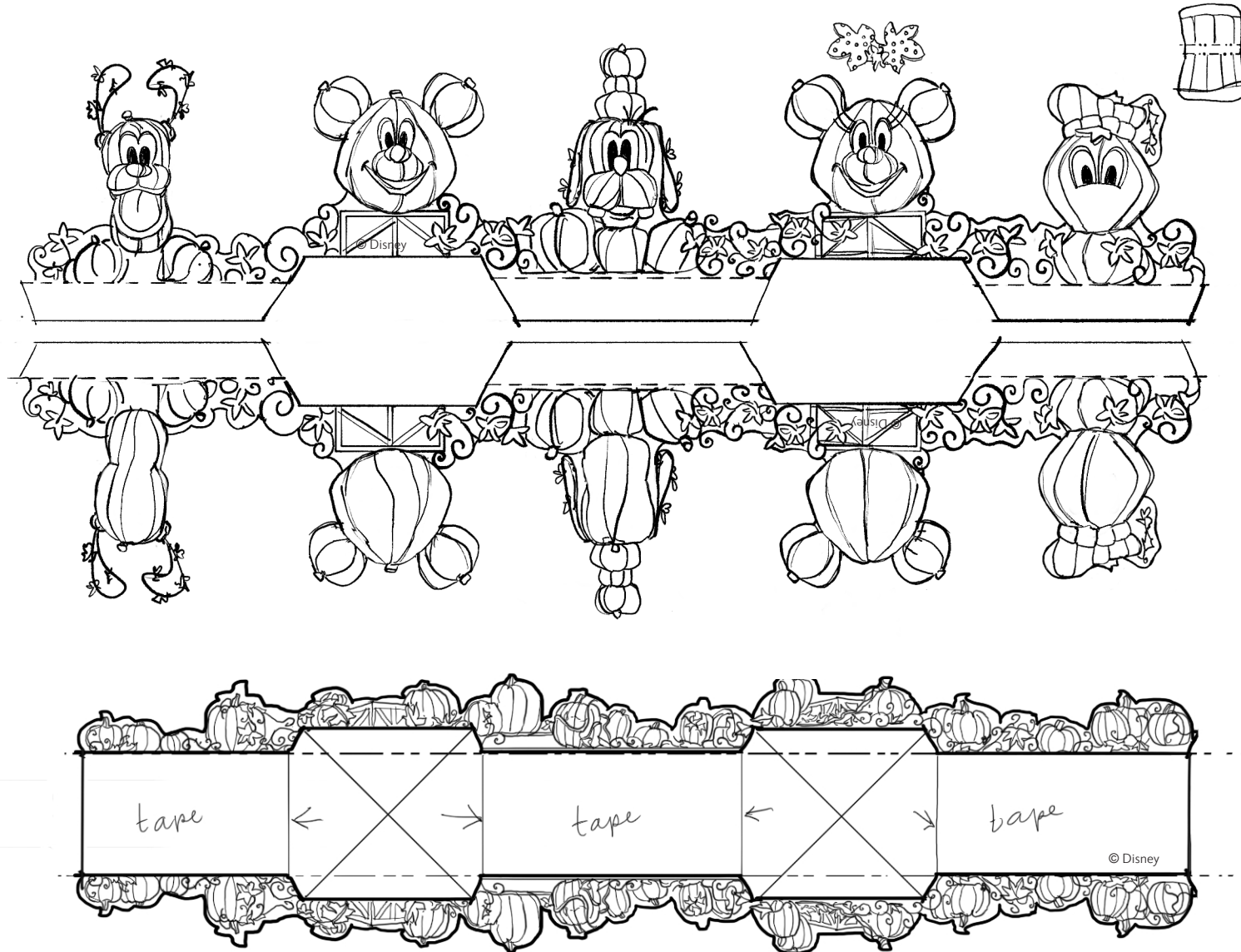

Donald's Bill

Tip! Fold along the lines first, then cut the diagonals. Then unfold and finish cutting out the middle parts to nest over the roof.



Disney Paper Parks

#DisneyMagicMoments | #DisneyPaperParks

DISNEYLAND ENTRY GATES

Sheet Number: 4

Donald's Bill

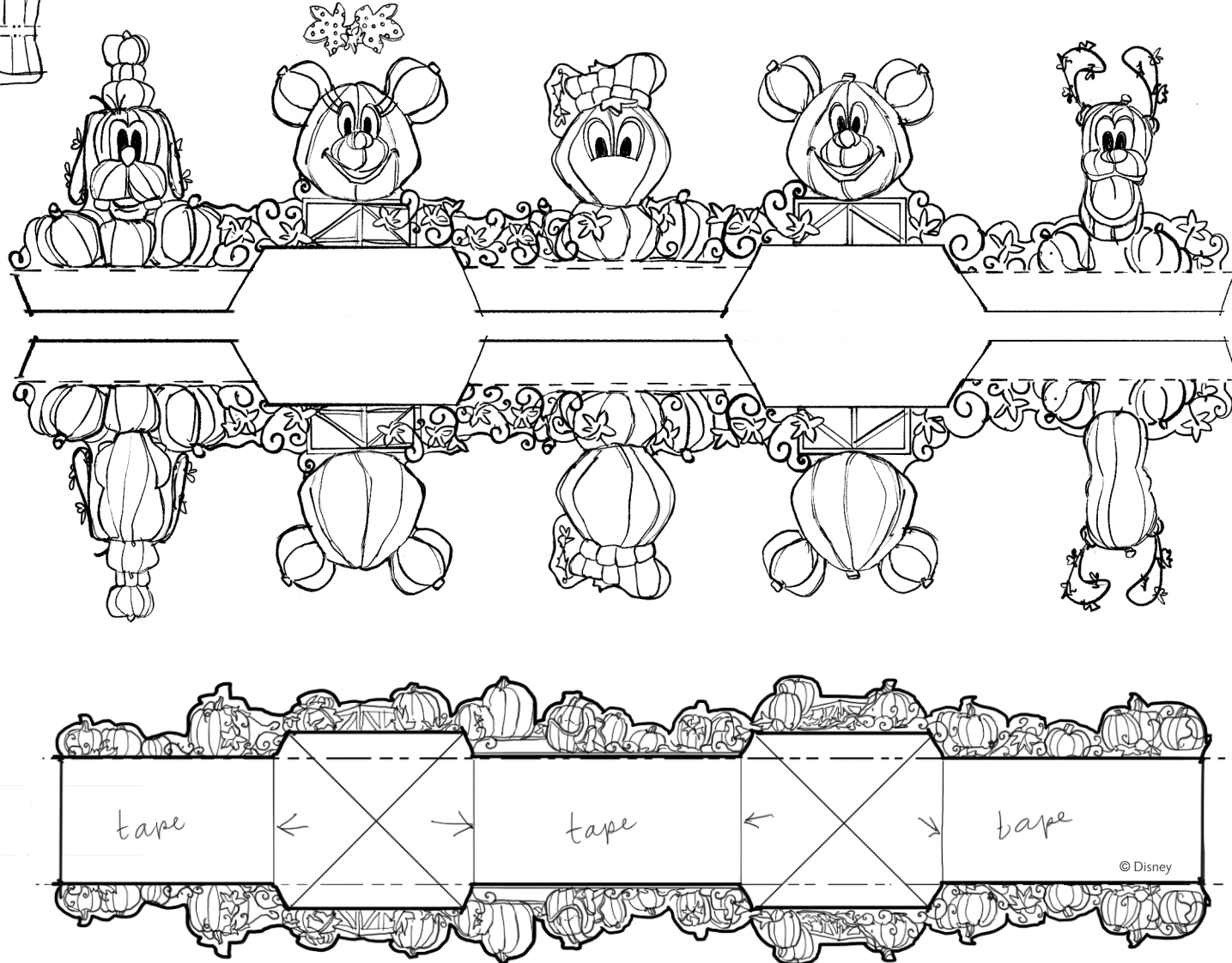
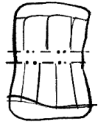

Tip! Fold along the lines first, then cut the diagonals. Then unfold and finish cutting out the middle parts to nest over the roof.



Disney Paper Parks

#DisneyMagicMoments | #DisneyPaperParks

HAUNTED MANSION DECORATIONS

Sheet Numbers: 1, 2, 3, 4, 5, 6, & 7

HISTORY

Walt Disney Imagineers care about every detail in all of our many parks, and here is a great example. Have fun assembling replicas of the brass bat stanchion toppers and chains. These can be found in the loading area of the attraction as you climb into your Doom Buggy.

Make as many copies as you like to create long paper chains of thorns and vines. Accent with Disney's Haunted Mansion wallpaper characters, made into a spooky paper chain design.

Welcome your guests in Disney's Haunted Mansion Style!

MATERIALS



GUIDE

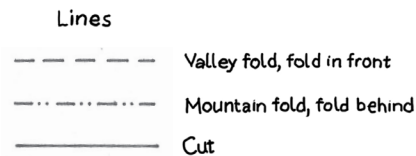

Please Note: When cutting with scissors and working with any of the materials listed above, adult participation and supervision is recommended.

INSTRUCTIONS



image 1



image 2



image 3

1. Color the pages with crayons, colored pencils, or whatever you would like to use.
2. Cut along solid lines where indicated.
3. Fold tabs and pieces according to Guide.
4. Cut the plastic straw to measure approximately 4 inches. Take piece 2 (bat back) and tape the plastic straw to the inside of the bat as shown in image 1.
5. Glue both sides of the bat together at the base of the wings and the head/feet, with the straw inside to add depth to the head and body.
6. Attach any paper chain you want to the bats wings, using the open connection detail at the wing ends on piece 2. See image 2.
7. Pieces 4 through 7 are other paper chain designs to use. Make multiple copies and have fun mixing the patterns together to form long paper chain swags.
8. For the "Welcome Foolish Mortal" signs, pieces 9, 10 and 11. Attach to any paper chain design using piece 8 as shown in image 3.



Disney Paper Parks

#DisneyMagicMoments | #DisneyPaperParks

Sheet Number: 1

HAUNTED MANSION DECORATIONS

Bat

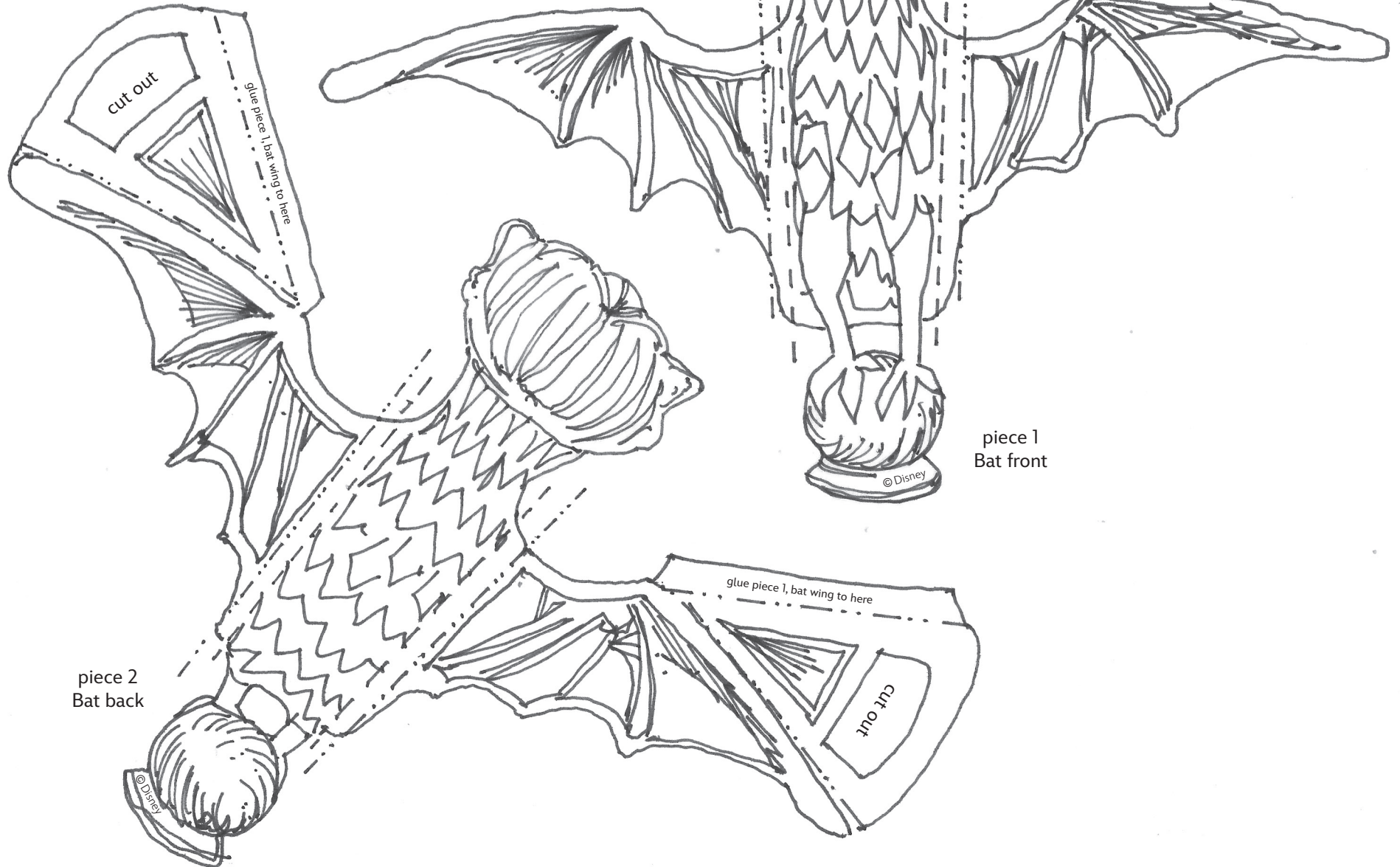

piece 1
Bat front

piece 2
Bat back

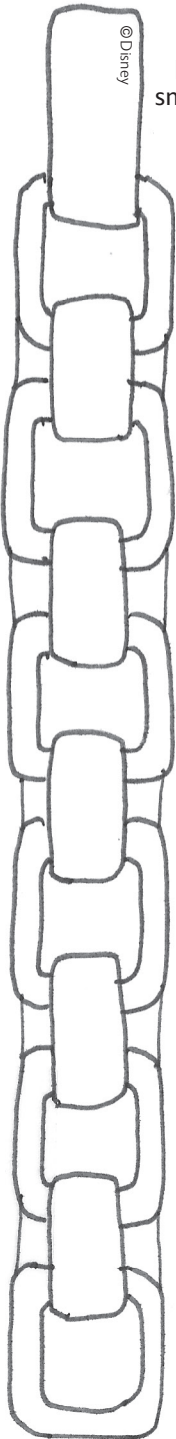

piece 3
small links

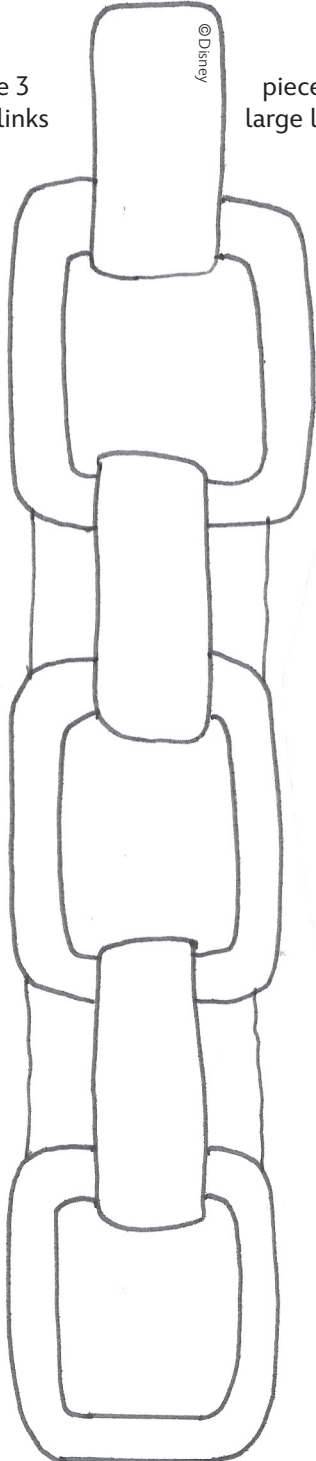

piece 4
large links



piece 5
wallpaper
chain

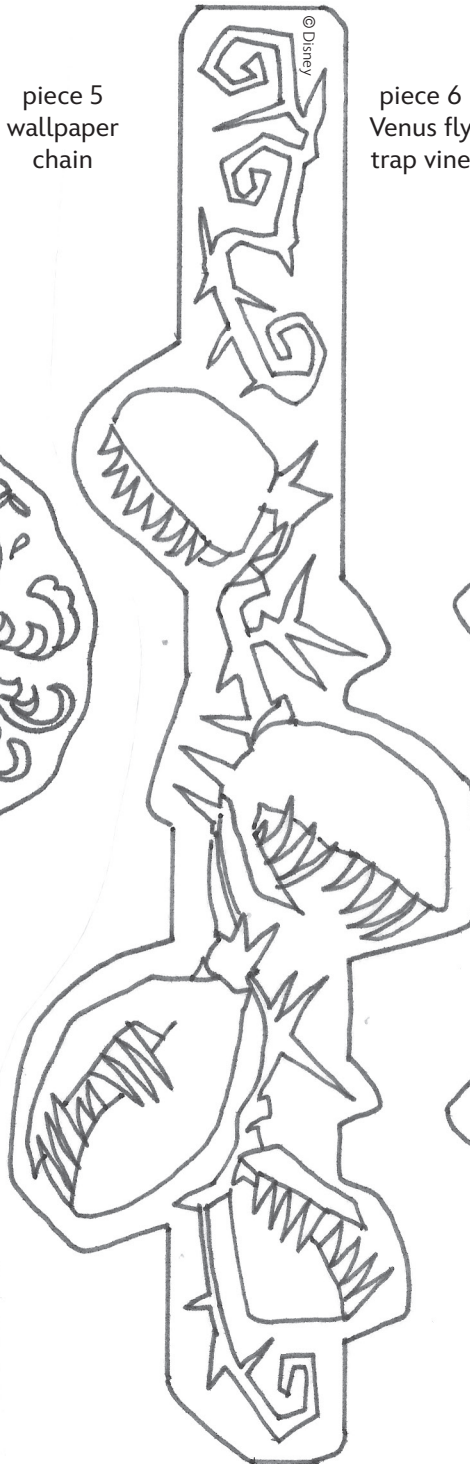

piece 6
Venus fly
trap vine



piece 7
thorny vine



Disney Paper Parks

**HAUNTED MANSION
DECORATIONS**
Paper Chains

Sheet Number: 2



Disney Paper Parks

**HAUNTED MANSION
DECORATIONS**
Paper Chains

Sheet Number: 3

piece 3
small links

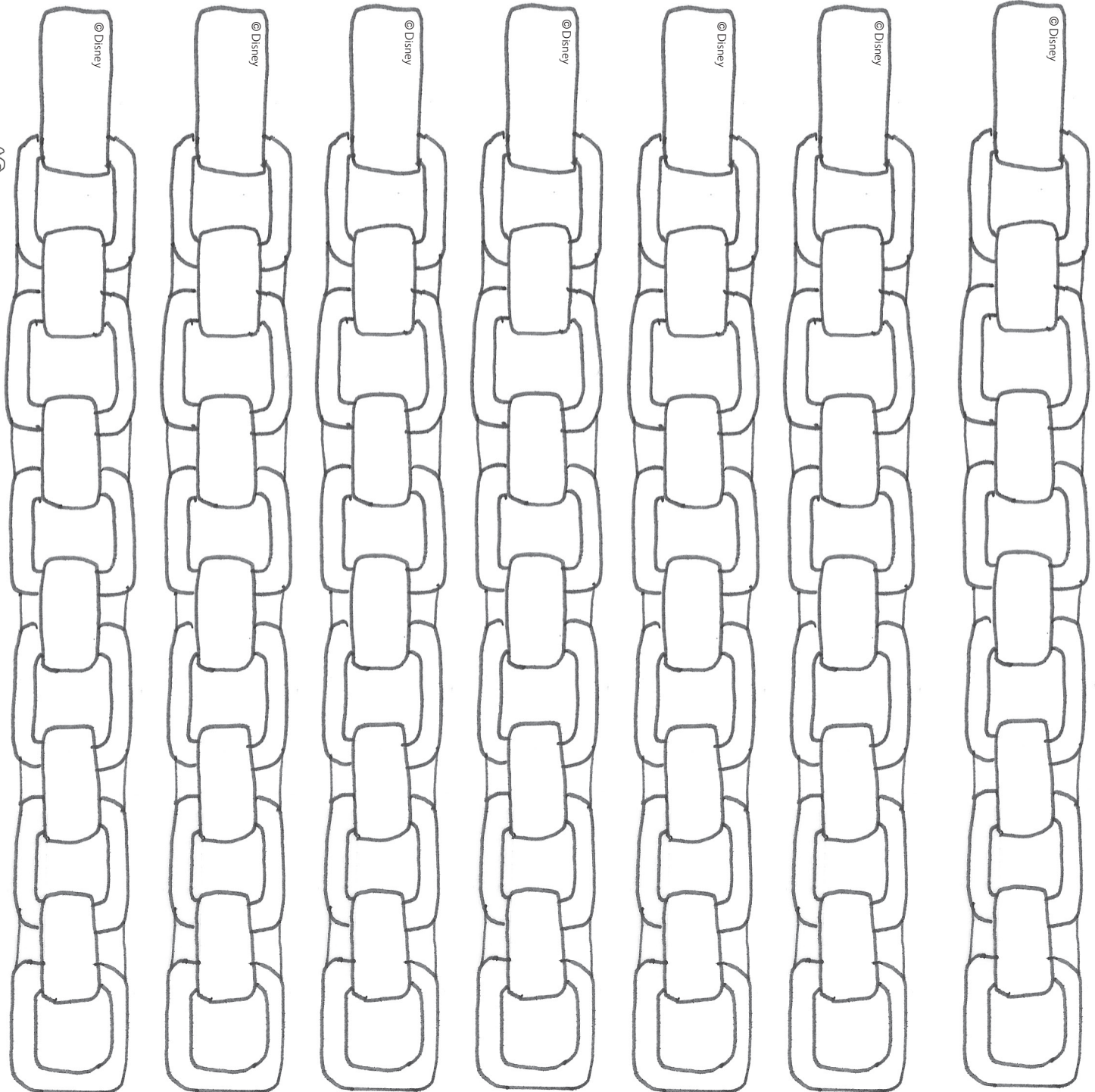



HAUNTED MANSION DECORATIONS Wrought Iron

Sheet Number: 4

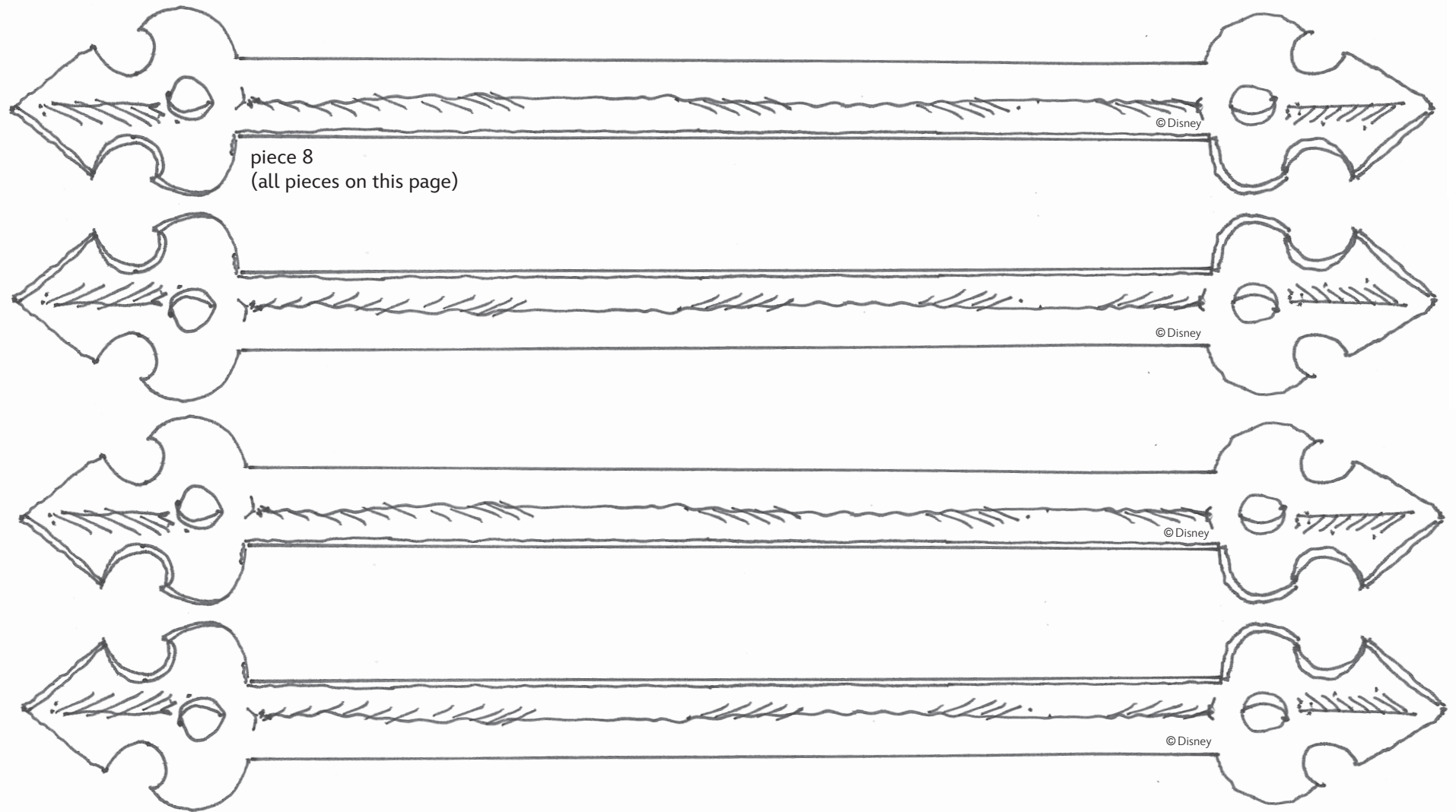



HAUNTED MANSION DECORATIONS

Welcome Sign

Sheet Number: 5



glue wrought iron end here. (piece 8)

piece 9
Welcome sign

glue wrought iron end here. (piece 8)



HAUNTED MANSION DECORATIONS

Foolish Sign

Sheet Number: 6

glue wrought iron end here. (piece 8)

piece 10 Foolish sign

glue wrought iron end here. (piece 8)

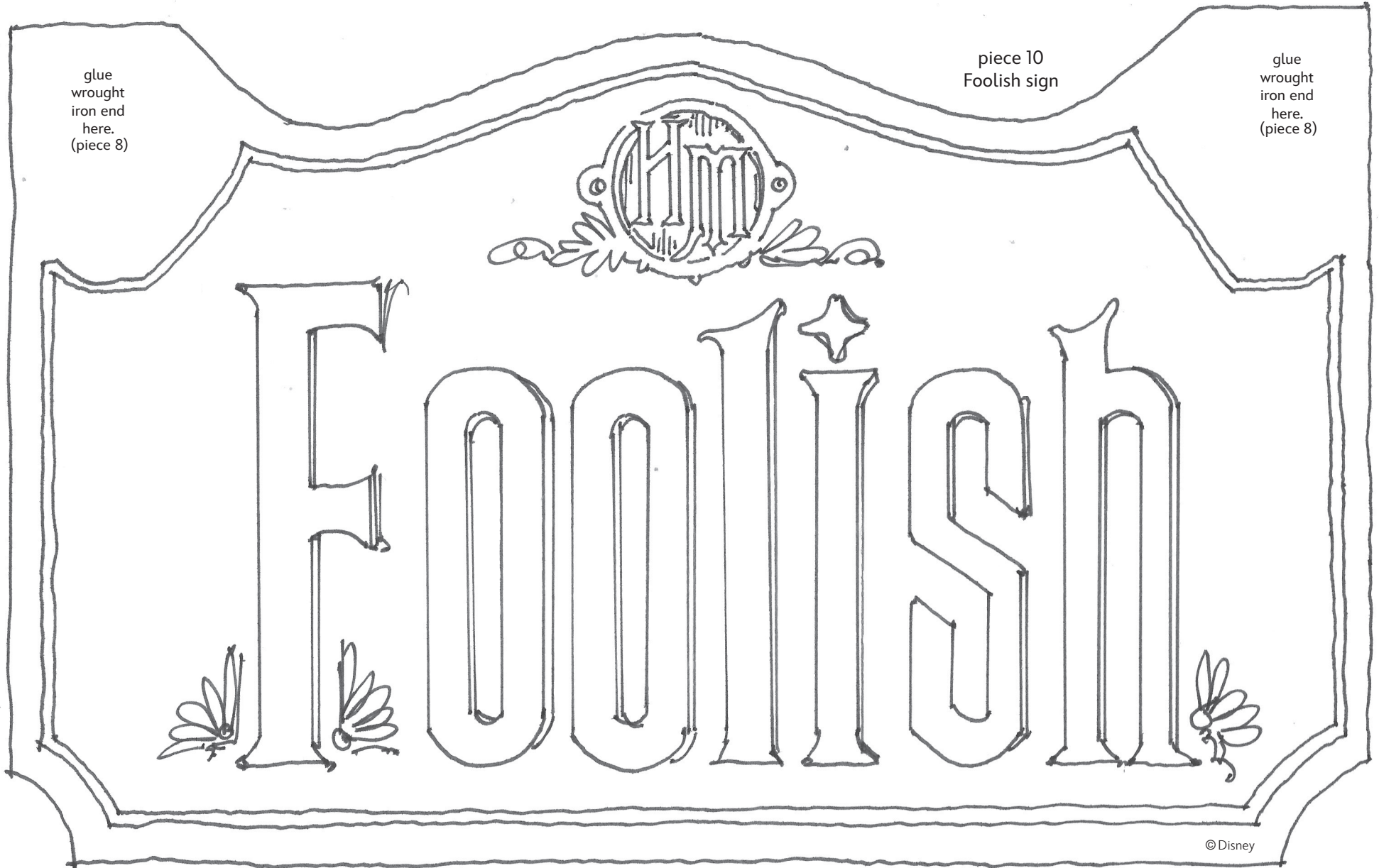



HAUNTED MANSION DECORATIONS Mortals Sign

Sheet Number: 7

glue
wrought
iron end
here.
(piece 8)

piece 11
Mortals sign

glue
wrought
iron end
here.
(piece 8)

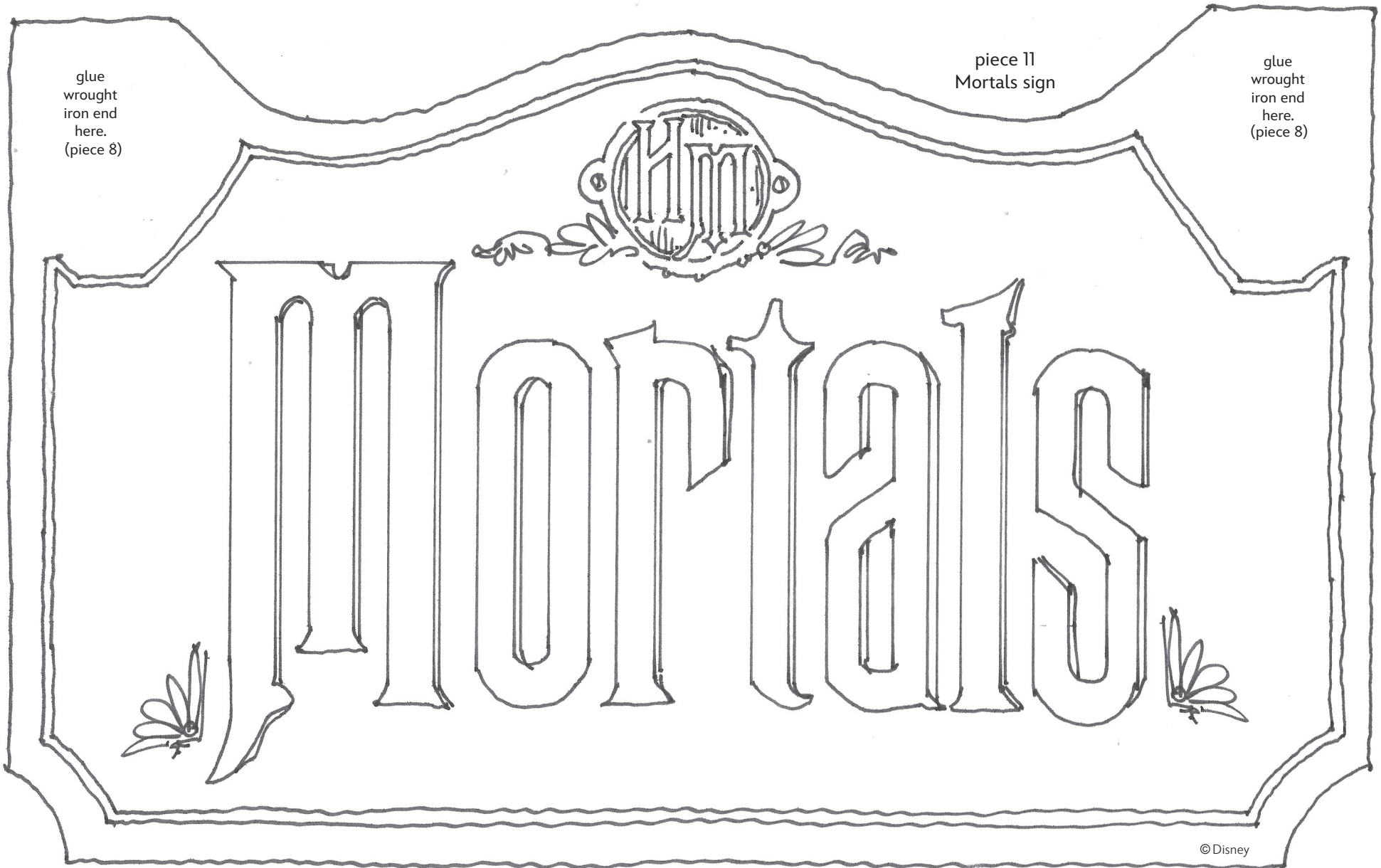



Disney Paper Parks

#DisneyMagicMoments | #DisneyPaperParks

GRINNING GHOSTS SHADOW PUPPETS

Sheet Numbers: 1, 2 & 3

HISTORY

At the core of every Disney attraction and place is a great story with memorable characters. The Haunted Mansion is one of the most treasured examples of where this all comes to life.

It's an attraction of illusions.

One of the great storytelling mechanisms used in the Haunted Mansion is through a play of shadows. You don't need candlelight or moonlight this time. Grab a flashlight and help these grinning ghosts come out to socialize in your own home!

INSTRUCTIONS

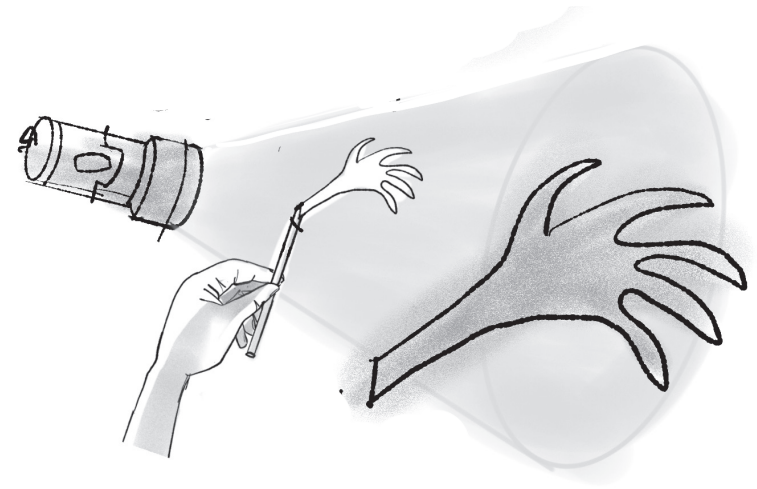

MATERIALS



Glue



Scissors



Tape



String

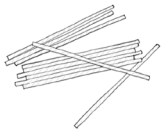

paper straws



brad fasteners

GUIDE

Lines

- Valley fold, fold in front
- - - - - Mountain fold, fold behind
- Cut
- X-ray or guide line.

1. Refer to the diagrams on the next page to show how each puppet is meant to be assembled.

SOME IMPORTANT TIPS!

- Use paper straws (or bamboo skewers) to make the paper stiff. We recommend gluing it to the back, but tape works as well.
- If you have a hole punch, that works well for cutting eyes for the ghosts.
- If there is a central piece that's difficult to cut, you can cut through the exterior and tape it up again! The important thing is the shadow it casts, so it's perfectly fine if the puppet looks a little messy.

Please Note: When cutting with scissors and working with any of the materials listed above, adult participation and supervision is recommended.



Disney Paper Parks

#DisneyMagicMoments | #DisneyPaperParks

GRINNING GHOSTS SHADOW PUPPETS

Model Diagrams

Rotating Hand Shadow

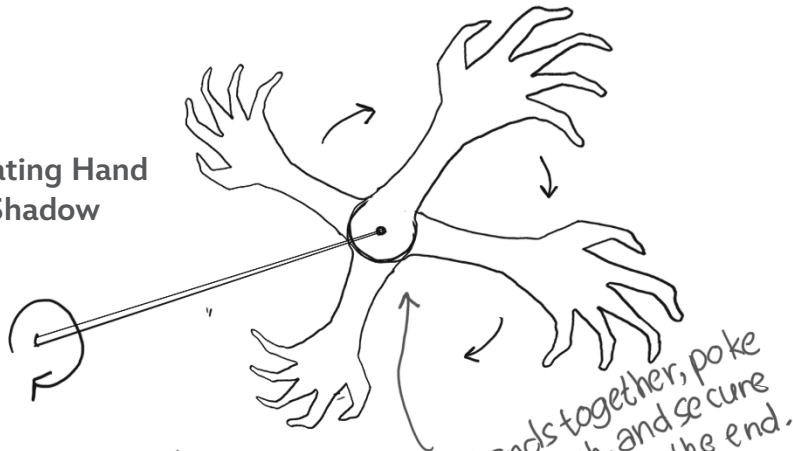

Madame Leota



glue the hands together, poke the stick through, and secure with a dot of glue at the end.

attach wings using a brad fastener

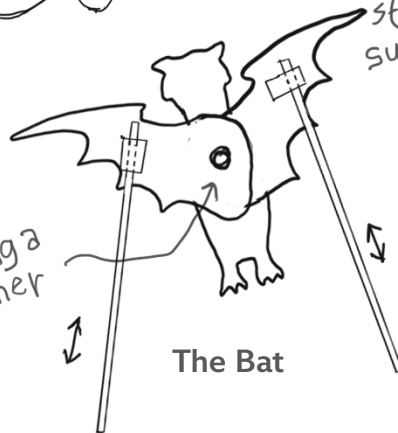

The Bat

Sally Slater



use a brad fastener. We recommend punching a hole first!

attach separate sticks or straws to support and allow mobility

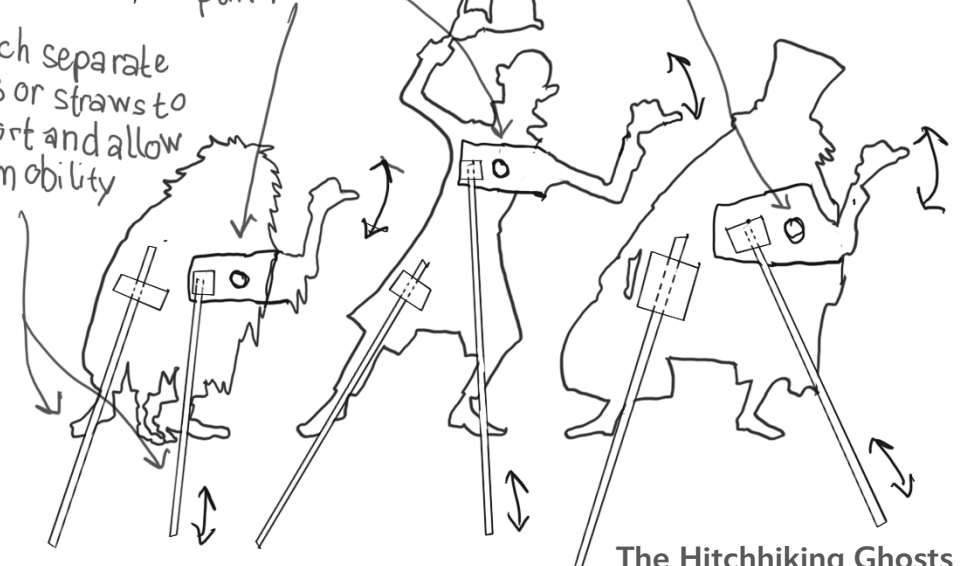

The Hitchhiking Ghosts

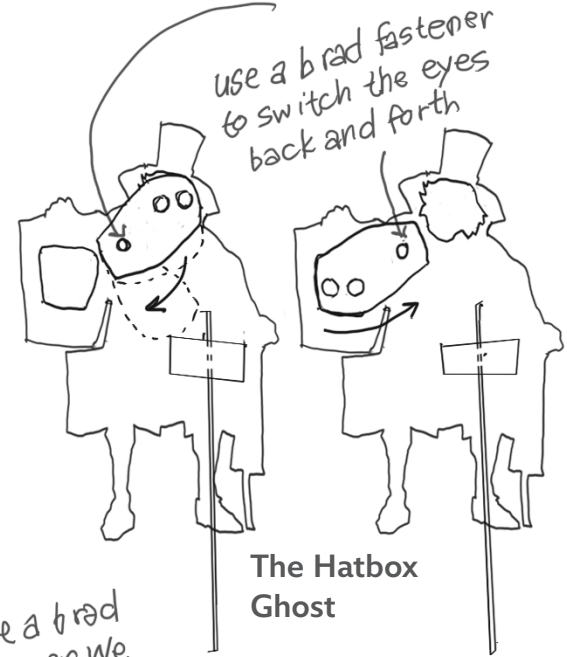

The Hatbox Ghost

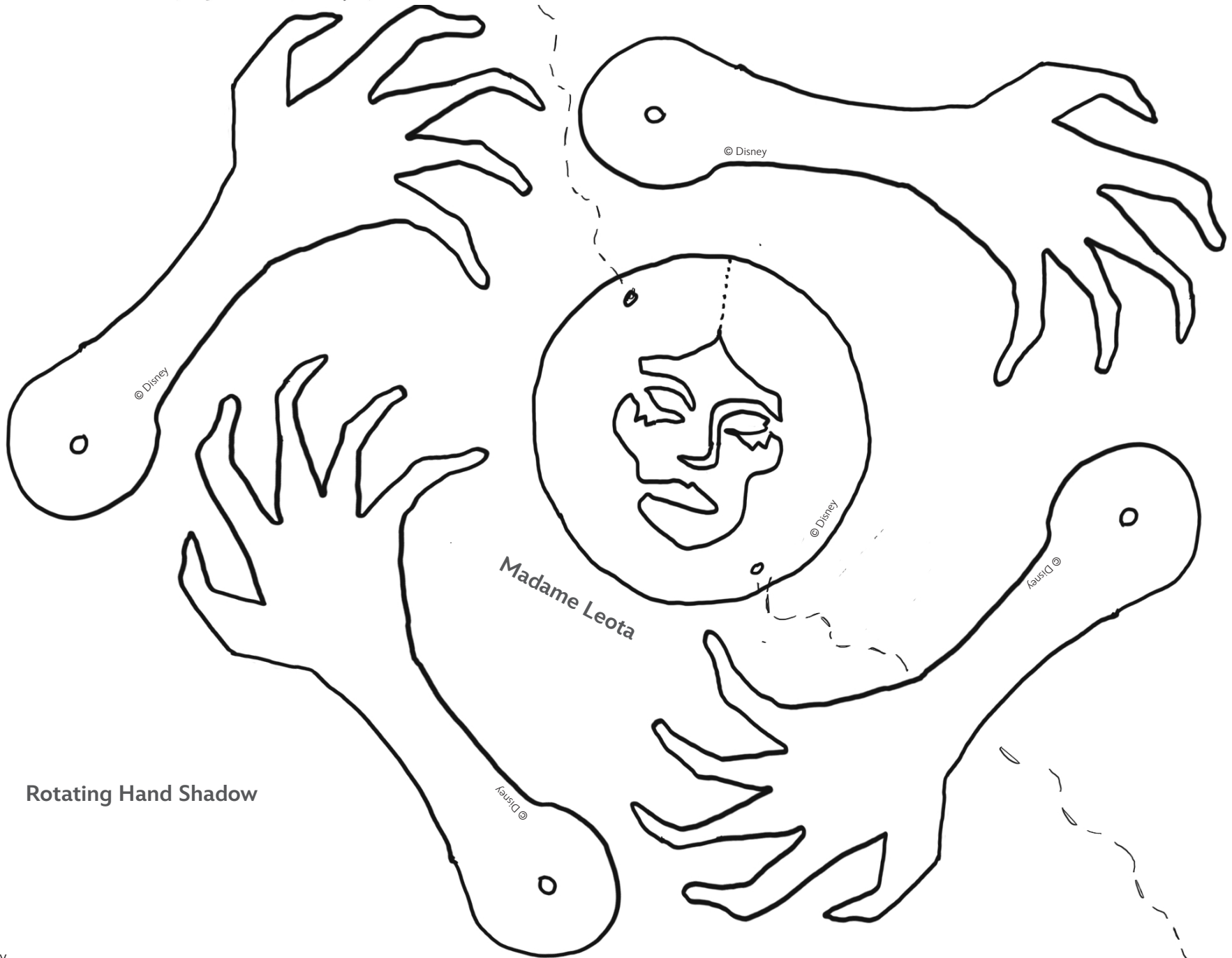

Rotating Hand Shadow



Sally Slater



The Bat

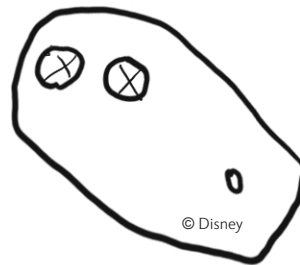
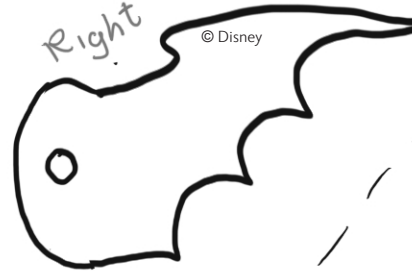
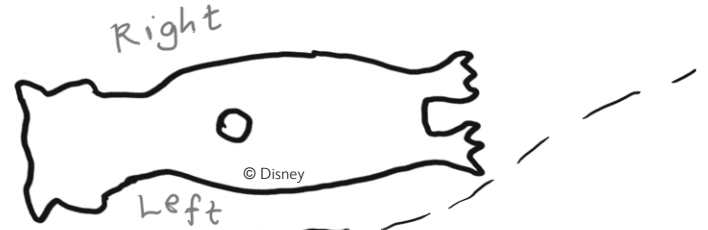

The Hatbox Ghost

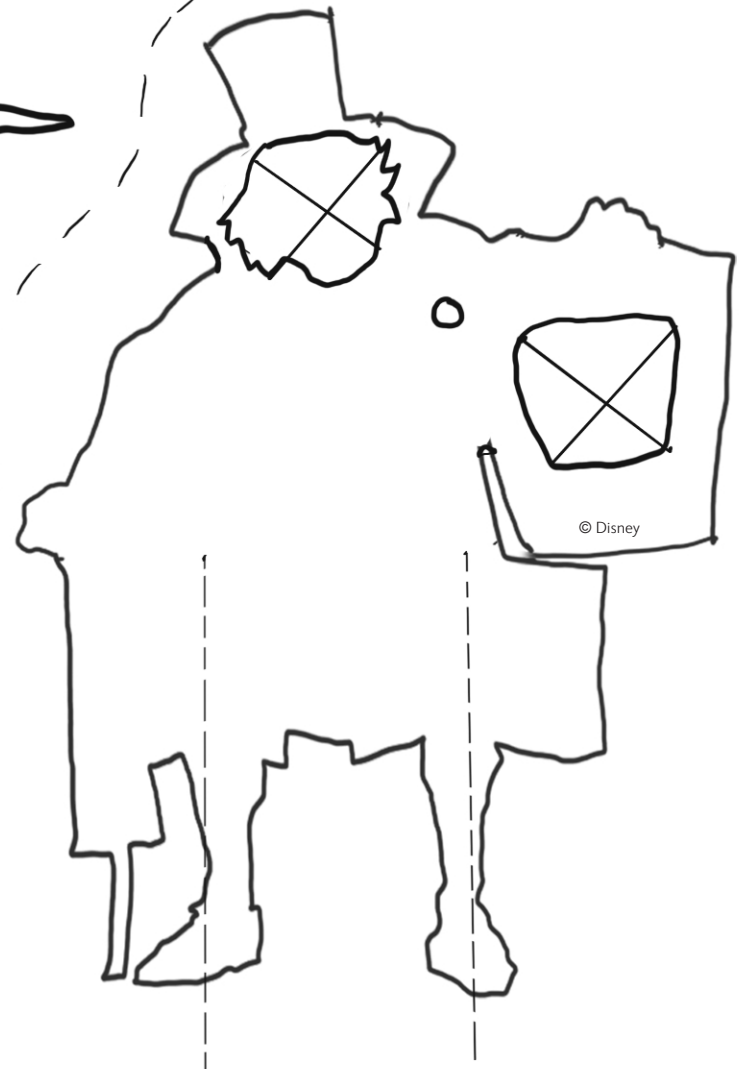



The Hitchhiking Ghosts

